



SAMSUNG

ECO HEATING SYSTEM

OUTDOOR UNIT

HYDRO UNIT

Model: AE040XEDEH
AE060XEDEH
AE090XEDEH
AE120XEDEH
AE140XEDEH
AE160XEDEH
AE090XEDGH
AE120XEDGH
AE140XEDGH
AE160XEDGH

AE090JNYDEH
AE090JNYDGH
AE160JNYDEH
AE160JNYDGH

SERVICE Manual

ECO HEATING SYSTEM



CONTENTS

1. Precautions
2. Product Specifications
3. Disassembly and Reassembly
4. Troubleshooting
5. PCB Diagram
6. Wiring Diagram
7. Reference Sheet

1. Precautions

1-1 Precautions for the Service

- **Use the standard parts when replacing the electric parts.**
 - Confirm the model name, rated voltage, rated current of the electric parts.
- **When repairing the equipment, connection of the harness parts must be firm and solid.**
 - A loose connection may cause noise or other malfunction.
- **When assembling and disassembling the equipment while it is laid down, lay it on soft cloth.**
 - Otherwise it may scratch the back of the exterior of the product.
- **Remove dust or dirt completely from the housing block, wiring block and service parts during repair.**
 - This helps prevent the danger of fire caused by tracking or short circuit.
- **Fasten the valve caps of service valves and charging valves of outdoor unit as much as possible using adjustable wrenches.**
- **Check the status of the components' assembly after repair service.**
 - The status must be the same as before the repair service.

1-2 Precautions related to static electricity and PL

- **The PCB power supply block is susceptible to static electricity. Therefore, care must be taken during repair or measuring while the power is on.**
 - Wear insulation gloves for PCB repair or measuring.
- **Check whether the installation location is at least two meters away from other electronic products such as TV, video, or audio.**
 - Otherwise, the video quality might be degraded or noise might be generated.
- **Do not let end users repair the products themselves.**
 - Unauthorized disassembly might cause electric shock or fire.

1-3 Precautions for the Safety

- **Do not pull any electric wires and do not touch an auxiliary power switch with a wet hand.**
 - There is a danger of electric shock or fire.
- **In case any wire or power plug has been damaged, replace it to eliminate any possible danger.**
- **Do not bend the power cord by force and do not put any heavy object on the power cord.**
 - There is a danger of electric shock or fire.
- **Do not use multi socket.**
 - There is a danger of electric shock or fire.
- **Ground the product if necessary.**
 - Be sure to ground the product if there is any danger of electric leakage due to water or moisture.
- **Be sure to turn off the auxiliary power switch or pull out the power plug during replacement or repair of electric parts.**
 - There is a danger of electric shock.
- **The installation must be done by the manufacturer or its service agent or a similar qualified person in order to avoid a hazard.**
 - Installation by an unqualified person may cause a water leakage, electric shock or fire and so on.
- **The electric work must be done by service agent or similarly qualified persons according to national wiring regulations and use only rated cable.**
 - If the capacity of the power cable is insufficient or electric work is not properly completed, electric shock or fire may occur.
- **Use only rated parts and tools.**
 - If you don't use the rated parts and tools, it can cause trouble with the air conditioner and bring about injury.
- **If any gas or impurities except R410A refrigerant come into the refrigerant pipe, serious problem may occur and it may cause injury.**
- **Leak test must be done using only Nitrogen(NO₂)gas.**

- R410A refrigerant is used for EHS.
 - When using R410A, moisture or foreign substances may affect to the capacity and reliability of the product. Safety precautions must be taken when installing the refrigerant pipe.
 - The design pressure of the unit is 4.1MPa. Select appropriate material and thickness according to the regulations.
 - R410A is a quasi-azeotrope of two refrigerants.
Make sure to charge liquid one when adding refrigerant.
If you charge gaseous refrigerant, it may affect the capacity and reliability of the product as a result of change formation of the refrigerant.

1-4 Precautions for handling a system containing refrigerants

All system containing refrigerants shall be removed under regional regulations prior to the disposal to prevent the potential health and environmental consequences.

- **Harmful for human body**
 - When emitted liquid refrigerant contacts human body, contacted area may get frostbite, blister or become numb.
 - If refrigerant leaks in airtight area, lack of oxygen may cause suffocation. When refrigerant is heated, it may generate harmful gas.
- **Precautions for handling container**
 - Do not apply shock or heat to the refrigerant container.

1-5 Precautions for the brazing

- **Clear any dangerous or inflammable materials in surrounding environment.**
- **Make sure to empty the remaining refrigerant in the product or pipe before brazing.**
 - Brazing with the refrigerant still remaining in the product or pipe may cause poor result and generate harmful gas. Furthermore, pressure of the refrigerant may increase and cause damage to the leaking part. This may lead harmful refrigerant and oil to spurt out which can be dangerous for service personnel.
- **Use nitrogen gas to get rid of the oxide forming during brazing.**
 - Using other type of gas may cause damage to the product or the exterior.

1-6 Precautions for charging refrigerants

- **Add quantity of the refrigerant using a scale and perform a test operation with S-net.**
 - Product performance may decrease if you add excessive amount of refrigerant.
- **Do not charge refrigerants while heating the container up.**
 - The container may get damaged by the heat and result in explosions.
- **Do not operate the product without pressure switch(for product protection) and sensor.**
 - If there are any internal blockage, high refrigerant pressure increase may damage the product or exterior.

2. General Overview

2-1 Features of the System

POWER SAVING

EHS(Eco Heating System) considers the trend in air conditioner use. It optimizes the energy efficiency of loads ranging from partial to full. It achieves an excellent energy effect for the users of the air conditioner.

Samsung patented compressor

Samsung has been researching and developing compressors since the 70's. It has developed power saving compressors for more than thirty years.

The **EHS(Eco Heating System)** compressor adopts a double-rotor BLDC compressor with permanent magnets made by Samsung. Electricity for the compressor rotor is obtained from a neodymium-iron-boron permanent magnetic material (boron magnet can attract iron material weighing 1000 times its own weight.) It strengthens the rotary moment of the compressor to maximize the entire efficiency of the compressor.

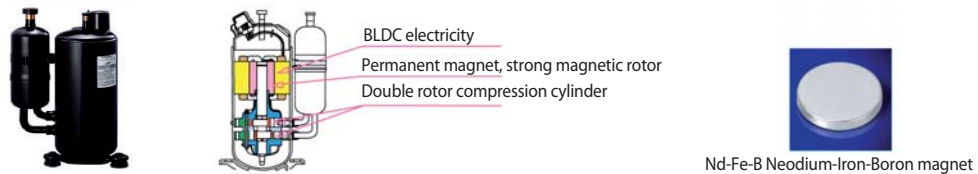

SAMSUNG's double-rotor compressor has the upper and lower rotors designed symmetrically. The double rotor in symmetry can remove vibrations caused by the eccentric design of the cylinder.

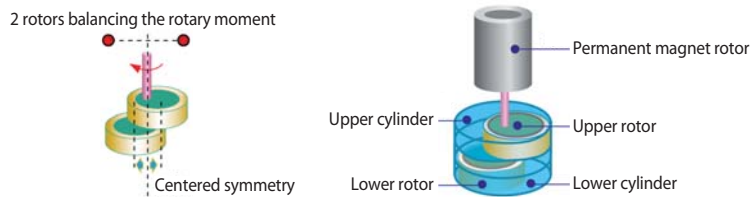

High efficiency heat exchanger

EHS(Eco Heating System) uses new multiple-teeth screw pipes with a diameter of 8 mm to improve the heat exchangeability of the pipe by **30.8%**.

The water-friendly aluminum foil in the heat exchanger uses the G-fin patent design to improve the efficiency of heat exchange by **13%**.



DC fan electricity

The **EHS(Eco Heating System)** outdoor machine uses DC fan electricity. The rotational speed of electricity is 100 RPM to 1050 RPM with step-free control. The electrical efficiency is improved by about **33%** compared to AC electricity.

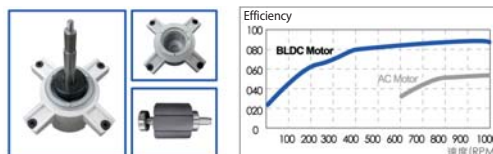

2-1-1 Key features of the EHS(SPLIT)

■ Integrated Heating & Cooling system

Plate Heat exchanger is an integral part in heating & cooling system. For user's convenience, PHE is integrated into the system. This concept will help space saving and lower costs for pipe line reduction.

■ Running Costs-Reduction of Up to 33.5%

Samsung EHS, known for its world class efficiency (12kW floor heating system with 4.63), can reduce 33.5% of your running costs as compared to a gas boiler.

■ High Performance at Low Temperature





Samsung EHS is made up of an inverter compressor optimally operated according to the outdoor temperature, offering heating performance of 90% at -10°C and reliable frost protection at -25°C.

■ Heat pump operating range of DHW : -25 ~ 35 °C

At the temperature below -25 °C, operation is available but correct performance cannot be guaranteed.

2-2 Product Specifications

2-2-1 Outdoor Unit

Model Code			AE040JXEDEH/EU	AE060JXEDEH/EU	AE090JXEDEH/EU	AE090JXEDGH/EU	AE120JXEDEH/EU	AE140JXEDEH/EU	AE160JXEDEH/EU	AE120JXEDGH/EU	AE140JXEDGH/EU	AE160JXEDGH/EU
Outdoor Unit												
A2W Condition #1. (A7/W35) *1	Nominal Capacity	W	4,400	6,000	9,000	9,000	12,000	14,000	16,000	12,000	14,000	16,000
		Btu/h	15,000	20,500	30,700	30,700	40,900	47,800	54,600	40,900	47,800	54,600
		W	5,000	6,500	8,000	7,500	12,000	14,000	15,000	12,000	14,000	15,000
		Btu/h	17,100	22,200	27,300	25,600	40,900	47,800	51,200	40,900	47,800	51,200
	Power Input (Nominal)	W	860	1,250	2,010	2,010	2,590	3,150	3,760	2,590	3,150	3,760
	Current Input (Nominal)	A	4.1	5.7	9.2	3.3	11.7	14.3	16.9	4.1	4.7	5.7
	COP (Nominal Heating)	W/W	5.10	4.80	4.48	4.48	4.63	4.44	4.26	4.63	4.44	4.26
EER (Nominal Cooling)	W/W	3.97	3.71	3.64	3.64	3.87	3.68	3.62	3.87	3.68	3.62	
A2/W35	Capacity	W	3400	4600	7700	7700	9800	11200	12500	9800	11200	12500
	COP	W/W	3.52	3.31	3.38	3.38	3.28	3.25	3.14	3.28	3.25	3.14
A-7/W35	Capacity	W	3750	5100	7600	7600	10,300	11,800	13,400	10,300	11,800	13,400
	COP	W/W	2.62	2.49	2.45	2.45	2.57	2.55	2.50	2.57	2.55	2.50
Field Wiring	MCA	A	20	20	22	10	28	30	32	10	11	12
	MFA	A	25	25	27.5	12.5	35	37.5	40	12.5	13.8	15
	Power Source Wire	m'		←	←	←	←	←	←	←	←	←
	Transmission Cable	m'		←	←	←	←	←	←	←	←	←
Refrigerant Connections	Liquid Pipe	Φ, mm	6.35	6.35	6.35	6.35	9.52	9.52	9.52	9.52	9.52	9.52
		Φ, inch	1/4	1/4	1/4	1/4	3/8	3/8	3/8	3/8	3/8	3/8
	Gas Pipe	Φ, mm	15.88	15.88	15.88	15.88	15.88	15.88	15.88	15.88	15.88	15.88
		Φ, inch	5/8	5/8	5/8	5/8	5/8	5/8	5/8	5/8	5/8	5/8
	Installation Limitation	Max. Length (Outdoor to, m)	30	30	50	50	50	50	50	50	50	50
		Max Height (Between ID/OD, m)	20	20	30	30	30	30	30	30	30	30
Chargeless Length	m	15	15	15	15	15	15	15	15	15	15	
Refrigerant	Type	-	R410A	R410A	R410A	R410A	R410A	R410A	R410A	R410A	R410A	R410A
	Control Method	-	EEV	EEV	EEV	EEV	EEV	EEV	EEV	EEV	EEV	EEV
	Factory Charging	g	1,400	1,400	1,700	1,900	2,980	2,980	2,980	2,980	2,980	2,980
Power Supply		Φ, #, V, Hz	E(220~240V, 50Hz, 1Φ)	E(220~240V, 50Hz, 1Φ)	E(220~240V, 50Hz, 1Φ)	G(380~4150V, 50Hz, 3Φ)	E(220~240V, 50Hz, 1Φ)	E(220~240V, 50Hz, 1Φ)	E(220~240V, 50Hz, 1Φ)	G(380~4150V, 50Hz, 3Φ)	G(380~4150V, 50Hz, 3Φ)	G(380~4150V, 50Hz, 3Φ)
Sound *3	Sound Pressure	Heating Std	dB(A)	46	47	49	49	50	50	52	50	50
		Cooling Std	dB(A)	46	47	50	50	50	52	54	50	52
	Sound Power	Heating Std	dB(A)	61	61	64	64	64	64	66	64	64
		Cooling Std	dB(A)	63	63	63	63	64	66	69	64	66
External Dimension	Net Weight		kg	48.5	48.5	68.0	76.0	100.0	100.0	100.0	101.5	101.5
	Shipping Weight		kg	51.5	51.5	78.0	84.5	109.5	109.5	109.5	111.0	111.0
	Net Dimensions (WxHxD)		mm	880 x 638 x 310	880 x 638 x 310	940 x 998 x 330	940 x 998 x 330	940 x 1,420 x 330	940 x 1,420 x 330	940 x 1,420 x 330	940 x 1,420 x 330	940 x 1,420 x 330
	Shipping Dimensions (WxHxD)		mm	1,023 x 725 x 413	1,023 x 725 x 413	995 x 1,178 x 426	995 x 1,178 x 426	995 x 1,598 x 426	995 x 1,598 x 426	995 x 1,598 x 426	995 x 1,598 x 426	995 x 1,598 x 426
Operating Temp. Range	A2W	℃	-25~35	-25~35	-25~35	-25~35	-25~35	-25~35	-25~35	-25~35	-25~35	-25~35
		℃	10~46	10~46	10~46	10~46	10~46	10~46	10~46	10~46	10~46	10~46
		℃	-25~43	-25~43	-25~43	-25~43	-25~43	-25~43	-25~43	-25~43	-25~43	-25~43

*1) A2W Condition #1 : (Heating) Water In/Out 30°C/35°C, Outdoor Air 7°CDB/6°CWB; (Cooling) Water In/Out 23°C/18°C, Outdoor Air 35°CDB.

*2) A2W Condition for ESEER(Cooling) at Water Out 18°C.





















*3) Sound pressure was acquired in an anechoic room. Thus actual noise level may be different depending on the installation conditions.

Product Specifications (cont.)

Model Code			AE090JNYDEH/EU	AE160JNYDEH/EU	AE090JNYDGH/EU	AE160JNYDGH/EU	
Hydro Unit							
Water Connections	Water Flow Rate (Std)[H/C]		LPM	13/15	35/35	26/22	46/44
	Water Pressure (Max)		bar	3	3	3	3
	Water Pipe	Inlet	Φ, inch	BSPP male 1 1/4	BSPP male 1 1/4	BSPP male 1 1/4	BSPP male 1 1/4
		Outlet	Φ, inch	BSPP male 1 1/4	BSPP male 1 1/4	BSPP male 1 1/4	BSPP male 1 1/4
	Leaving Water Temperature	Heating	°C	25~55	25~55	25~55	25~55
Cooling		°C	5~25	5~25	5~25	5~25	
Refrigerant Connections	Liquid Pipe		Φ, mm	6.35	9.52	6.35	9.52
			Φ, inch	1/4	3/8	1/4	3/8
	Gas Pipe		Φ, mm	15.88	15.88	15.88	15.88
			Φ, inch	5/8	5/8	5/8	5/8
	Installation Limitation	Max. Length (Outdoor to indoor)	m	30	50	50	50
		Max. Height (Between ID/OD)	m	20	30	30	30
Chargeless Length		m	15	15	15	15	
Power Supply			Φ, #, V, Hz	E(220~240V, 50Hz, 1Φ)	E(220~240V, 50Hz, 1Φ)	G(380~4150V, 50Hz, 3Φ)	G(380~4150V, 50Hz, 3Φ)
Water Pump	Type		-	Centrifurugal (UPM3 25-7.5)	Centrifurugal (Stratos 25 1-9)	Centrifurugal (UPM3 25-7.5)	Centrifurugal (Stratos 25 1-9)
	Motor Input		W	60	90	60	90
	Number of Unit		EA	1	1	1	1
Flow Switch	Type		-	Magnetic, Decreasing	Magnetic, Decreasing	Magnetic, Decreasing	Magnetic, Decreasing
	Min. flow rates		LPM	7 ± 1.5	12 ± 1.5	7 ± 1.5	12 ± 1.5
Electric Heater			W	4,000	6,000	6,000	6,000
Expansion Vessel			Liter	8	8	8	8
Pressure Relief Valve			bar	2.9	2.9	2.9	2.9
Air Purge Valve			Φ, inch	BSPP male 3/8	BSPP male 3/8	BSPP male 3/8	BSPP male 3/8
Service Valve			Φ, inch	BSPP male 1 1/4	BSPP male 1 1/4	BSPP male 1 1/4	BSPP male 1 1/4
Sound *3	Sound Pressure	Heating Std	dB(A)	26	33	26	33
		Cooling Std	dB(A)	26	33	26	33
	Sound Power	Heating Std	dB(A)	40	47	40	47
External Dimension	Net Weight		kg	45.0	45.0	46.5	46.5
	Shipping Weight		kg	55.0	55.0	56.0	56.0
	Net Dimensions (WxHxD)		mm	510 x 850 x 315	510 x 850 x 315	510 x 850 x 315	510 x 850 x 315
	Shipping Dimensions (WxHxD)		mm	564 x 1,024 x 412	564 x 1,024 x 412	564 x 1,024 x 412	564 x 1,024 x 412

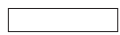







2-3 Specifications of optional items

2-3-1 Accessories

Item	Description	Code No.	Q'ty	Remark
	Cap Drain	DB63-10355C	5	Essential Offer (Outdoor Unit)
	Drain Plug	DB67-00806A	2	Provided for AE090/120/140/160 Models
	Drain Plug	DB67-00477A	1	Provided for AE040/060 Models
	Rubber Leg	DB73-20134A	4	Essential Offer (Outdoor Unit)
	ASSY-INSTALLATION MANUAL (Outdoor Unit)	DB68-05328A	1	Provided for AE090/120/140/160 Models
	ASSY-INSTALLATION MANUAL (Outdoor Unit)	DB68-05132A	1	Provided for AE040/060 Models
	ASSY-USER MANUAL	DB68-05130A	1	Essential Offer (Hydro unit)
	ASSY-INSTALLATION MANUAL	DB68-05131A	1	
	Pattern sheet	DB98-32365A	1	
	service valve	DB96-13833A/B	1	
	wall mounting bracket	DB61-04402A	1	
	ASSY THERMISTOR-WATER TANK	DB95-05023A	1	
	SENSOR TEMP-MIXING VALVE	DB32-00213A	1	
	Ring band	DB81-01572B	1	
	Sensor holder	DB61-40055A	1	
	Sensor clip	DB81-00635A	1	
	Cable-tie	DB65-10088C	4	
	Aluminum Tape	DB72-30040A	1	
	Rubber Tape	DB62-11304A	1	
	Insulator	DB62-04785A	1	
	Assy Connector Wire	DB93-13255A	1	

3. Disassembly and Reassembly





■ Hand Tool sets

Item	Remark
+Screw Driver	
Adjustable wrench	
-Screw Driver	
Nipper	
Electric Motion Driver	
L-Wrench	
Torque Lench	
Latchet Lench	

3-1 Hydro Unit

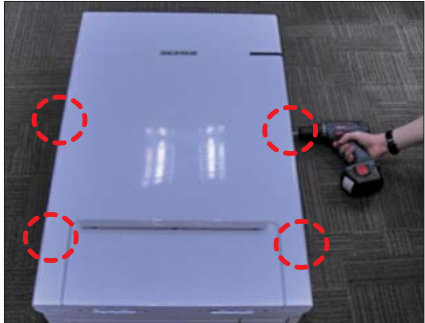
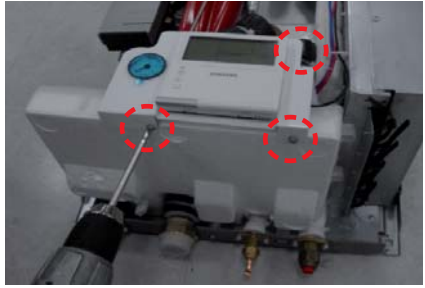

■ AEN160YD*/AEN080YD*

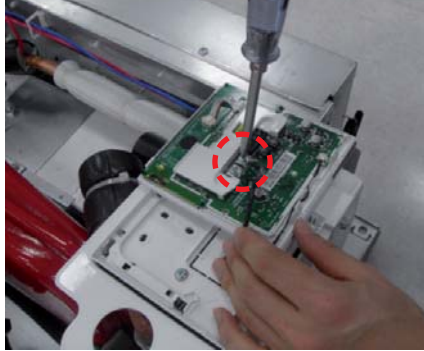
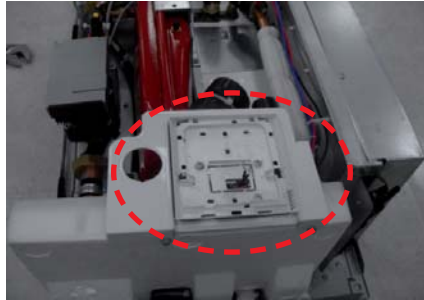
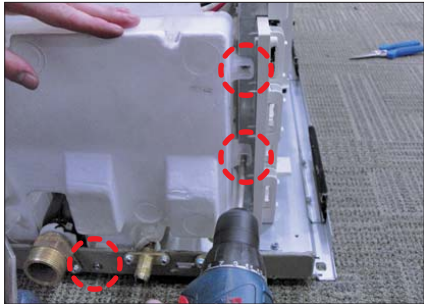
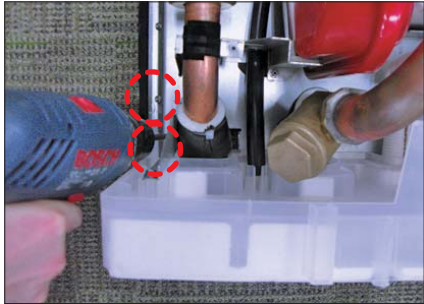

Be sure that the power switch is in the OFF and the power source cord shall be unplugged prior to disassembly and reassembly works.

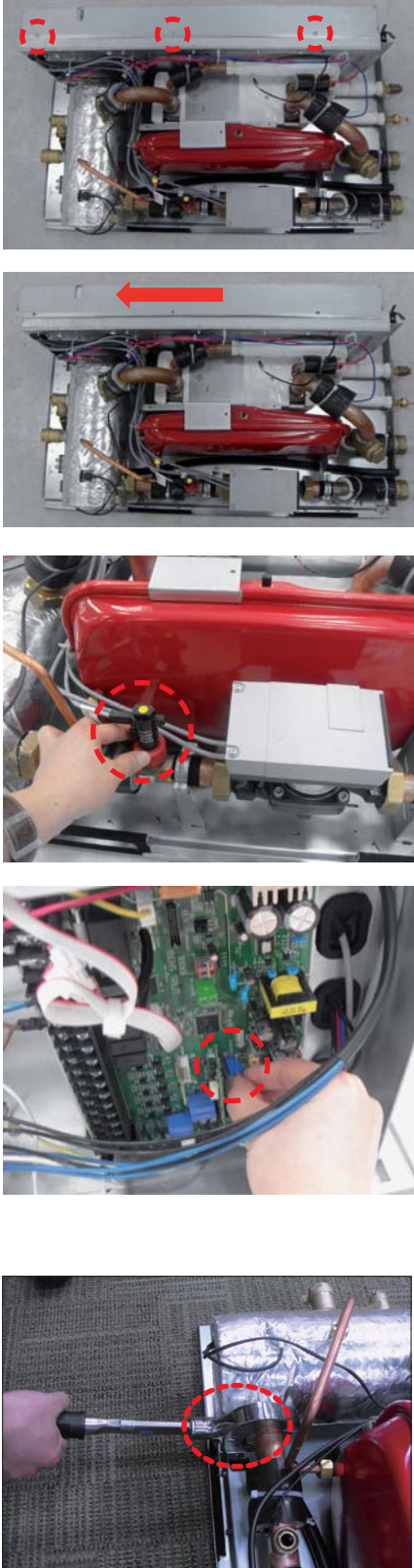
No	Parts	Procedure	Remark
1	Panel	1) Remove 4 cover screws from the Hydro Unit. (Use + Screw Driver)	
2	Controller & Manometer	1) Remove 3 screws from it. (Use + Screw Driver) 2) Remove pressure sensor by adjustable wrench. (Use adjustable wrench-230kgf-cm) 3) Pull the manometer out. 4) Push the 2 hooks of cover. 5) Pull the bottom of remocon body up.	    

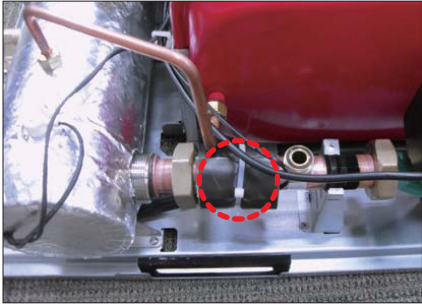

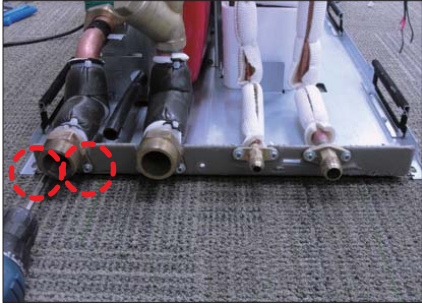
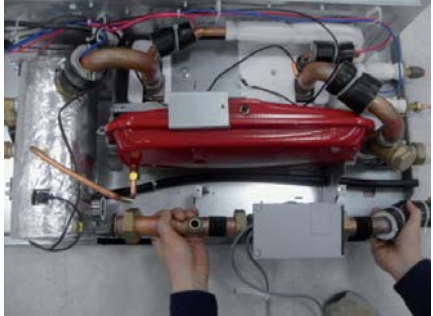

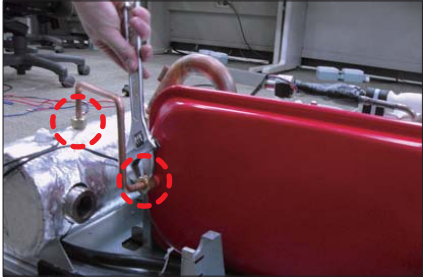
No	Parts	Procedure	Remark
		<p>5) Remove the connector from the PCB board.</p> <p>6) Remove the upper case of the controller.</p> <p>7) Remove 5 screws. Set a side the drain pan and hydro unit.</p>	   

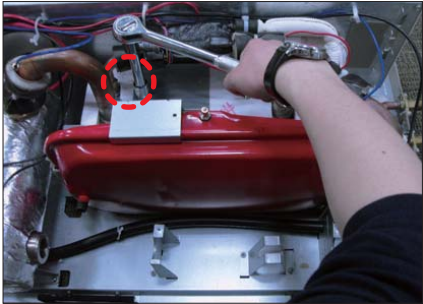
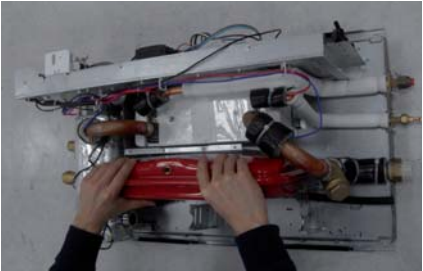
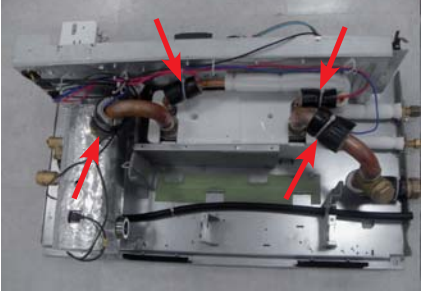
No	Parts	Procedure	Remark
3	Water Pump	<p>1) Remove 4 screws. (Use + Screw Driver)</p> <p>2) Remove the cabi-control top.</p> <p>3) Remove the flow switch and connector.</p> <p>4) Remove a pipe from the backup Heater. (Use adjustable wrench-380kgf.cm)</p> <p>⚠ Use the Torque Wrench when you assemble it.</p>	

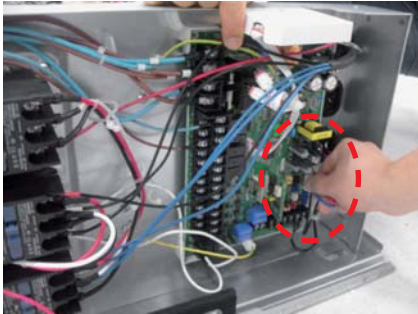
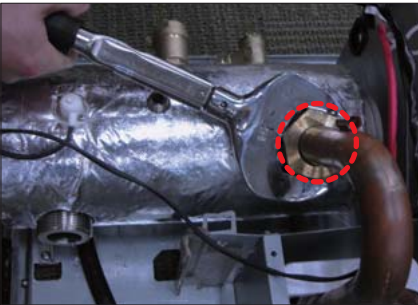
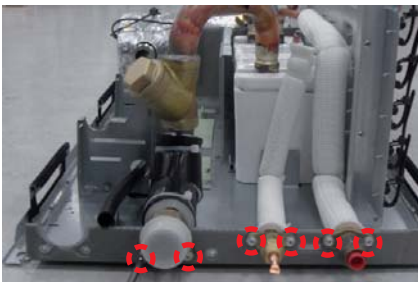
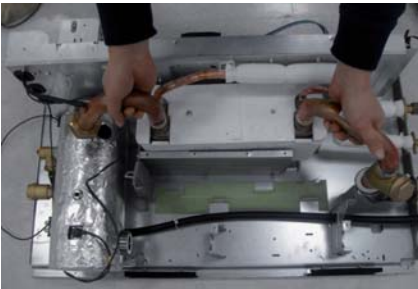
No	Parts	Procedure	Remark
		<p>5) After removing insulation material, remove the Thermostat.</p> <p>6) Remove 2 screws. (Use + Screw Driver)</p> <p>7) Remove 2 screws. (Use + Screw Driver)</p> <p>8) Pull the water pump & pipes up, out.</p>	  <p>AE160JNY***</p>  <p>AE090JNY***</p>  

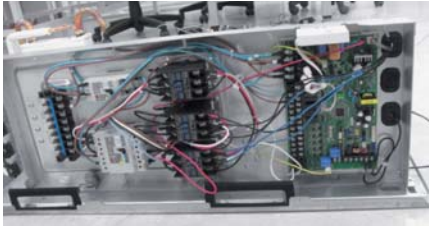

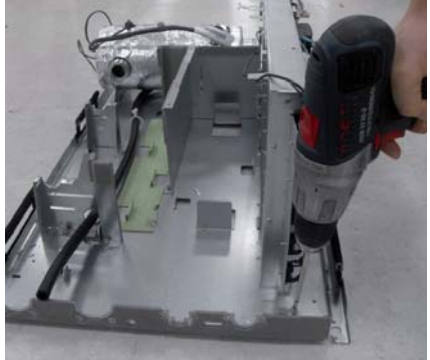
No	Parts	Procedure	Remark
4	Expansion Vessle	<p>1) Remove the tube of the expansion vessel and the backup heater by adjustable wrench. (Use adjustable wrench-150kgf-cm)</p> <p>⚠ Use the Torque Wrench when you assemble it.</p> <p>2) Remove 2 screws. (Use + Screw Driver)</p> <p>3) After removing the nut. Pull the bracket out.</p> <p>4) Pull the expansion vessel up, out.</p>	   
5	Plate Heat Exchanger	<p>1) Remove 4 insulations.</p>	



No	Parts	Procedure	Remark
		<p>2) Remove 4 Thermostats.</p> <p>3) Remove the Thermostat connector on the PCB of the Control box.</p> <p>4) Remove the pipe from the Backup Heater. (Use adjustable wrench-380kgf·cm)</p> <p>▲ Use the Torque Wrench when you assemble it.</p> <p>5) Remove 6 screws. (Use + Screw Driver)</p> <p>6) Pull the PHE out of the unit.</p>	    

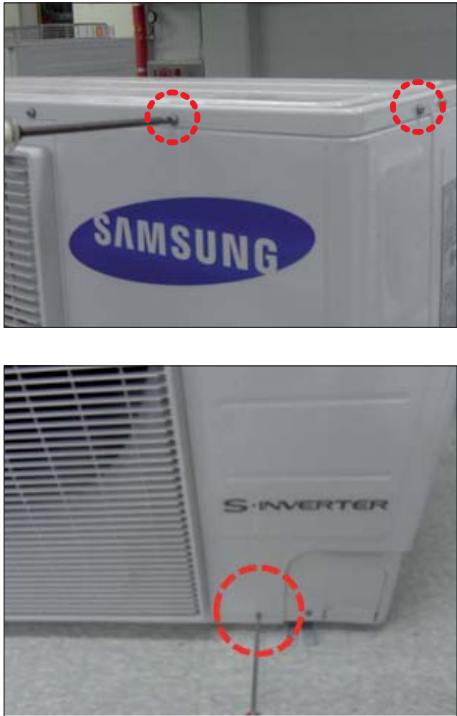

No	Parts	Procedure	Remark
6	Control Box	<p>1) Remove Thermostats and connectors</p> <p>2) Remove 3 screws. (Use + Screw Driver)</p> <p>3) Pull the cabi-control bottom out by pushing as indicated direction.</p>	 <p>3 Phase (AE***JNYDGH)</p>  <p>1 Phase (AE***JNYDEH)</p>   

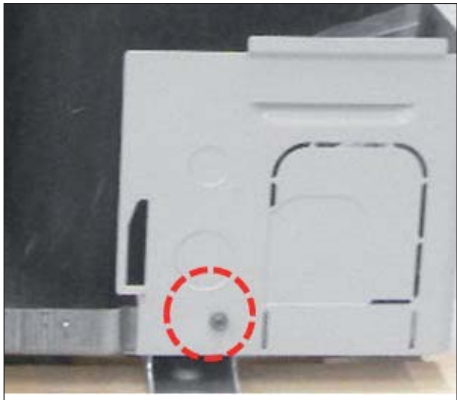

3-2 Outdoor Unit

■ AEX100ED*/AEX125ED*/AEX140ED*/AEX160ED*

No	Parts	Procedure	Remark
1	CABI FRONT RH	<p>⚠ You must turn off the power before disassembling.</p> <p>1) Unscrew and remove the three screws on the CABI FRONT RH. (Use '+' type screw driver)</p>	
2	CABI TOP	<p>1) Unscrew and remove the nine screws on each side of the CABI TOP. (Use '+' type screw driver)</p>	
3	CABI INSTALL FRONT	<p>1) Unscrew and remove the screw on the CABI INSTALL FRONT. (Use '+' type screw driver)</p>	

No	Parts	Procedure	Remark
4	GUARD COND	<p>1) Pull the sensor from Guard Cond.</p> <p>2) Unscrew and remove the four screws on the GUARD COND. (Use '+' type screw driver)</p>	 

No	Parts	Procedure	Remark
5	CABI BACK RH	<p>1) Pull the sensor from the CABI BACK RH.</p> <p>2) Unscrew and remove the nine screws on each side the CABI BACK RH. (Use '+' type screw driver)</p>	  

No	Parts	Procedure	Remark
			
6	CABI INSTALL BACK	1) Unscrew and remove the 8 screws on the CABI FRONT LF. (Use '+' type screw driver)	

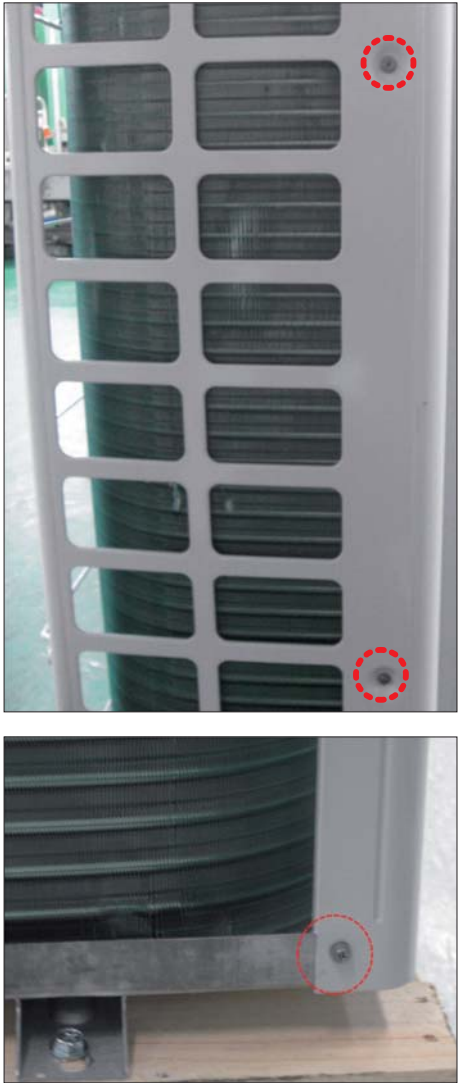

No	Parts	Procedure	Remark
			

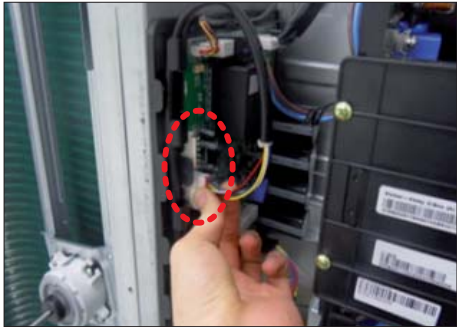
No	Parts	Procedure	Remark
7	FAN	1) Turn the two nuts as shown in the picture and remove them. (Use adjustable wrench)	

No	Parts	Procedure	Remark
8	MOTOR	<p>1) Remove the fan.</p> <p>2) Unscrew and remove the eight motor screws. (Use '+' type screw driver)</p> <p>3) Disconnect the motor wire from the Ass'y Control Out.</p>	 

No	Parts	Procedure	Remark
9	BRACKET MOTOR	1) Unscrew and remove the two screws on the BRACKET MOTOR. (Use '+' type screw driver)	

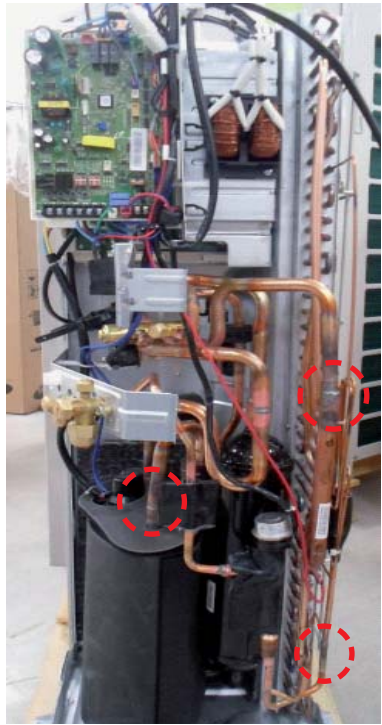

No	Parts	Procedure	Remark
10	CONTROL OUT	<p>1) Disconnect the six connectors from the ASSY Control OUT</p> <p>2) Unscrew and remove the three screws on the CONTROL OUT. (Use '+' type screw driver)</p> <p>3) Separate the ASSY CONTROL OUT.</p>	



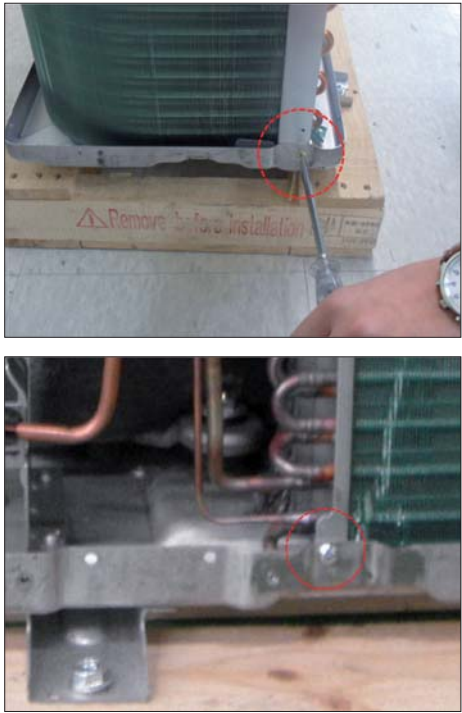

No	Parts	Procedure	Remark
11	ASSY 4WAY VALVE	<p>1) Purge the coolant first.</p> <p>2) Unscrew and remove the four screws on the SERVICE VALVE. (Use '+' type screw driver)</p> <p>3) Separate the pipe from the Entrance/Exit using a welder.</p> <p>⚠ When removing the compressor, heat exchanger and pipe, purge the completely and remove the pipe with a welding flame.</p>	  





No	Parts	Procedure	Remark
12	COMPRESSOR	<p>1) Unscrew and remove the nut on the COVER TERMINAL. (Use adjustable wrench)</p> <p>2) Separate the compressor wire.</p> <p>3) Separate the COMPRESSOR FELT SOUND.</p> <p>4) As shown in the picture, unscrew and bottom. (Use Adjustable Wrench)</p>	





No	Parts	Procedure	Remark
13	ASSY COND OUT	1) Unscrew remove the two screws on each side of the ASSY COND OUT. (Use '+' type screw driver)	

■ AEX060EDEHA

No	Parts	Procedure	Remark
1	Common Work	<p>1) Loosen 1 fixing screw of the Cover-Control and detach the Cover Control.</p> <p>2) Loosen fixing screws and detach the Cabinet-Upper.</p> <p>3) Loosen 1 screw fixed to assemble Control Box with Cabinet-Side RH.</p> <p>4) Loosen 6 fixing screws and detach the Cabinet-Side RH.</p>	   

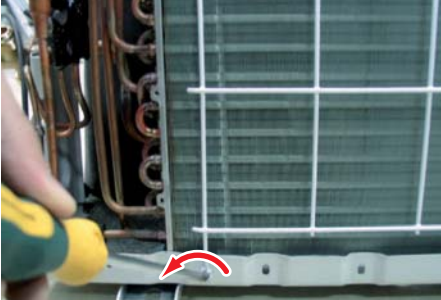
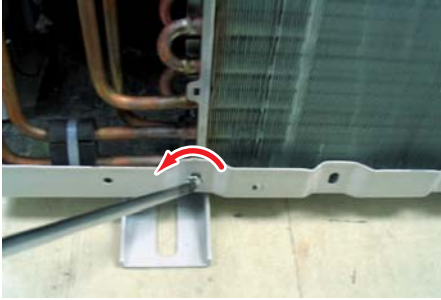
No	Parts	Procedure	Remark
		<p>5) Loosen 2 screws fixed on the Guide Condenser.</p> <p>6) Loosen fixing screws of the Cabinet Front.</p>	    

No	Parts	Procedure	Remark
2	Fan & Motor	<ol style="list-style-type: none"> 1) Detach the Nut Flange like the picture on the right side. (Turn clockwise because the screw is left-handed.) 2) Detach the Fan Propeller. 3) Loosen 4 fixing screws to detach the Motor. 4) Disconnect the wire between Ass'y Control Out and Motor. 5) Loosen 2 fixing screws and detach the Bracket Motor. 	   
3	Ass'y Control Out	<ol style="list-style-type: none"> 1) Detach several connectors from the Ass'y Control Out. 2) Detach several connectors from the PCB of Ass'y Control Out. 3) Pull up the Ass'y Control Out. 	

No	Parts	Procedure	Remark
4	Heat Exchanger	<ol style="list-style-type: none"> 1) Release the refrigerant at first. 2) Loosen fixing screw. 3) Disassemble the pipes in both inlet and outlet with welding torch. 4) Detach the Heat Exchanger. <p style="color: red;">*Before you disassemble the pipes and Condenser, be sure that there should be no refrigerant remained in the unit.</p> <ol style="list-style-type: none"> 1) Loosen fixing screw(CCW) and detach the Heat Exchanger 	 
5	Compressor	<ol style="list-style-type: none"> 1) Loosen the fixing nut and detach the Compressor Lead Wire. 2) Disassemble the Felt Comp Sound. <ol style="list-style-type: none"> 3) Loosen the 3 bolts at the bottom of Compressor like the picture on the right side. 	  

4. Troubleshooting

4-1 Wired remote controller

- Press the Test button to see the error code.

Error mode	Contents	Measure	Product operation in error condition	Error type
			Outdoor unit/ Compressor/Indoor unit	
U01	Indoor unit communication error	Check the communication cable of indoor unit. Check the DC output voltage at the communication terminal	Operation Off	Communication error
U21	Indoor temperature sensor (open/short error)	Check indoor unit room temperature sensor. Check indoor unit PCB connector CNS043(White)	Operation Off	Indoor sensor error
U22	Indoor unit Eva In sensor (Open/Short)	Check indoor unit pipe sensor. Check indoor PCB connector CN41(White)	Operation Off	Indoor sensor error
U23	Indoor unit Eva Out sensor disconnection	Check indoor unit pipe sensor. Check indoor PCB connector CNS043(White)	Operation Off	Indoor sensor error
U28	Indoor unit Eva In sensor detached from Eva In pipe.	Check indoor unit Eva In sensor location.	Operation Off	Indoor sensor error
U29	Indoor unit Eva Out sensor detached from Eva Out pipe.	Check indoor unit Eva In sensor location.	Operation Off	Indoor sensor error
U53	Indoor floating switch secondary detection	Check indoor unit float sensor. Check indoor PCB connector CNS041(Blue)	Operation Off	Self diagnostic error
202	Indoor/outdoor communication error (1 min)	Check the communication connection between indoor and outdoor units. Check the power line and communication cable connection status	Operation Off	Communication error
203	Communication error between indoor/outdoor INV↔MAIN MICOM (1 min)	Check MAIN MICOM Check INVERTER MICOM	-	Communication error
221	Outdoor temperature sensor error	Check sensor connection status Check sensor location Check sensor resistance	Operation Off	Outdoor sensor error
237	COND temperature sensor error	Check sensor connection status Check sensor location Check sensor resistance	Operation Off	Outdoor sensor error
257	[Inverter] Emission temperature sensor error	Check sensor connection status Check sensor location Check sensor resistance	Operation Off	Outdoor sensor error
486	Emission temperature excessively high	No error (DISCHARGE temperature control)	-	Outdoor unit protection control error
440	Heating operation blocked	Check the operation setting state Check temperature sensor	Operation Off	Self diagnostic error
447	Cooling operation blocked	Check the operation setting state Check temperature sensor	Operation Off	Self diagnostic error
458	Outdoor fan 1 error	Check input power connection status Check the connection status between the motor and outdoor unit PCB Check indoor/outdoor fuse	Operation Off	Self diagnostic error
467	[Inverter] Compressor startup error	Check the compressor connection status Check the resistance between difference phases of the compressor	Operation Off	Outdoor unit protection control error

Wired remote controller (cont.)

Error mode	Contents	Measure	Product operation in error condition	Error type
			Outdoor unit/ Compressor/Indoor unit	
462	[Inverter] Total current error/ PFC over current error	Check the input power Check the coolant charging status Check the normal operation of outdoor fan	Operation Off	Outdoor unit protection control error
464	[Inverter] IPM over current error	Check coolant charging Check the compressor connection status and normal operation Check the obstacles around the indoor and outdoor units Check whether the outdoor unit service valve is open Check whether the indoor/outdoor installation pipe/wiring are correct	Operation Off	Outdoor unit protection control error
465	Compressor V limit error	Check the compressor connection status Check the resistance between difference phases of the compressor	Operation Off	Outdoor unit protection control error
466	DC LINK over/low voltage error	Check input power Check AC power connection	Restart in 3 minutes	Outdoor unit protection control error
467	[Inverter] Compressor rotation error	Check the compressor connection status Check the resistance between difference phases of the compressor	Operation Off	Outdoor unit protection control error
468	[Inverter] Current sensor error	Check EEPROM DATA Check the normal operation of PCB	Operation Off	Outdoor unit protection control error
469	[Inverter] DC LINK voltage sensor error	Check the input power connection Check the status of RY21 and R200 in the INVERTER PCB	Operation Off	Outdoor unit protection control error
471	[Inverter] OTP error	Check EEPROM DATA Check the normal operation of PCB	Operation Off	Outdoor unit protection control error
472	AC ZERO CROSSING SIGNAL OUT error	Check the input power status	Operation Off	Outdoor unit protection control error
473	Compressor LOCK error	Check the compressor connection status Check the resistance between difference phases of the compressor	Operation Off	Outdoor unit protection control error
475	Outdoor fan 2 error	Check the input power connection status Check the connection status of the motor and the outdoor unit PCB Check the indoor/outdoor unit fuse	Operation Off	Self diagnostic error
554	Gas leak error	Check the coolant charging status Check the indoor EVA sensor Check if the outdoor unit service valve is open Check that the indoor/outdoor installation pipe/wiring are correct	Operation Off	Self diagnostic error
556	Capacities not matched	Check the option code of the indoor unit	Operation Off	Outdoor unit protection control error
601	Communication error between the indoor unit and wired remote controller	Check the connection wire between the indoor unit and the wired remote controller	Normal operation	Wired remote controller error
602	Communication error between the Master and Slave wired remote controllers	Check the option switch for defining the Master and Slave (only one Master and one Slave can exist)	Normal operation	Wired remote controller error

4-2 Troubleshooting by symptoms

4-2-1 Communication error after finishing Tracking

Indoor unit display	<i>E604</i>
Symptom	Communication error between the indoor and outdoor unit for two minutes
Failure	Communication error between the indoor unit and outdoor unit

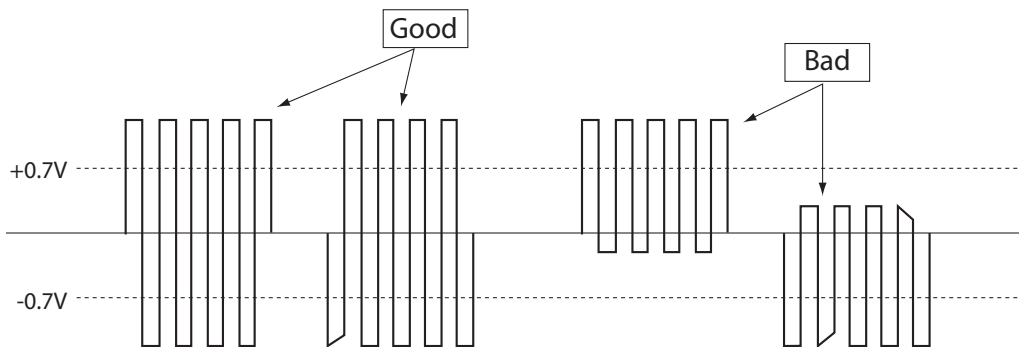
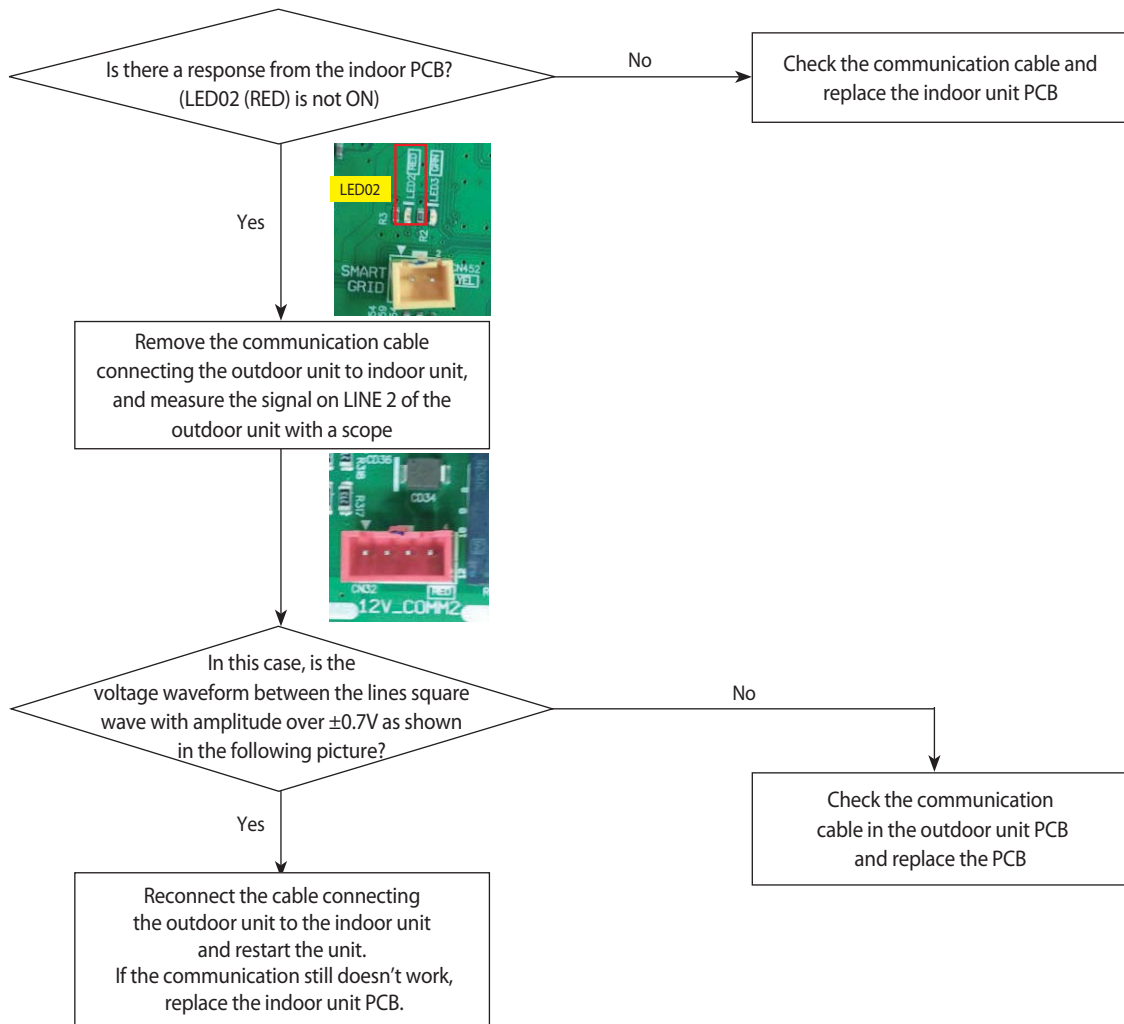

4-2-2 EEPROM circuit failure

Indoor unit display	<i>E 162</i>
Symptom	EEPROM circuit failure
Failure	EEPROM component failure, EEPROM circuit parts missing/damaged/soldering failure

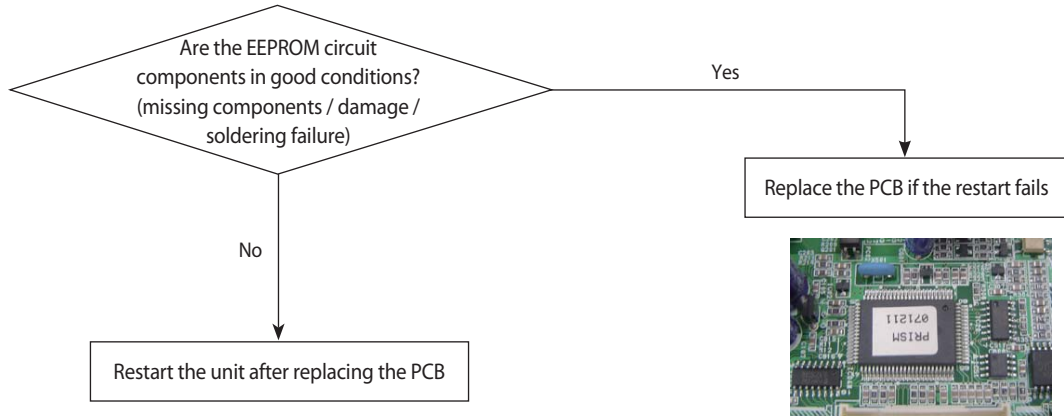

4-3 Hydro Unit

4-3-1 EEPROM error

Outdoor unit display	<i>E 162</i>
Indoor unit display	×(Operation) ●(Timer) ●(Fan) ●(Filter) ×(Defrost)
Criteria	• Communication failure between EEPROM and MICOM
Cause of problem	• PCB replacement due to defective EEPROM

1. How to check

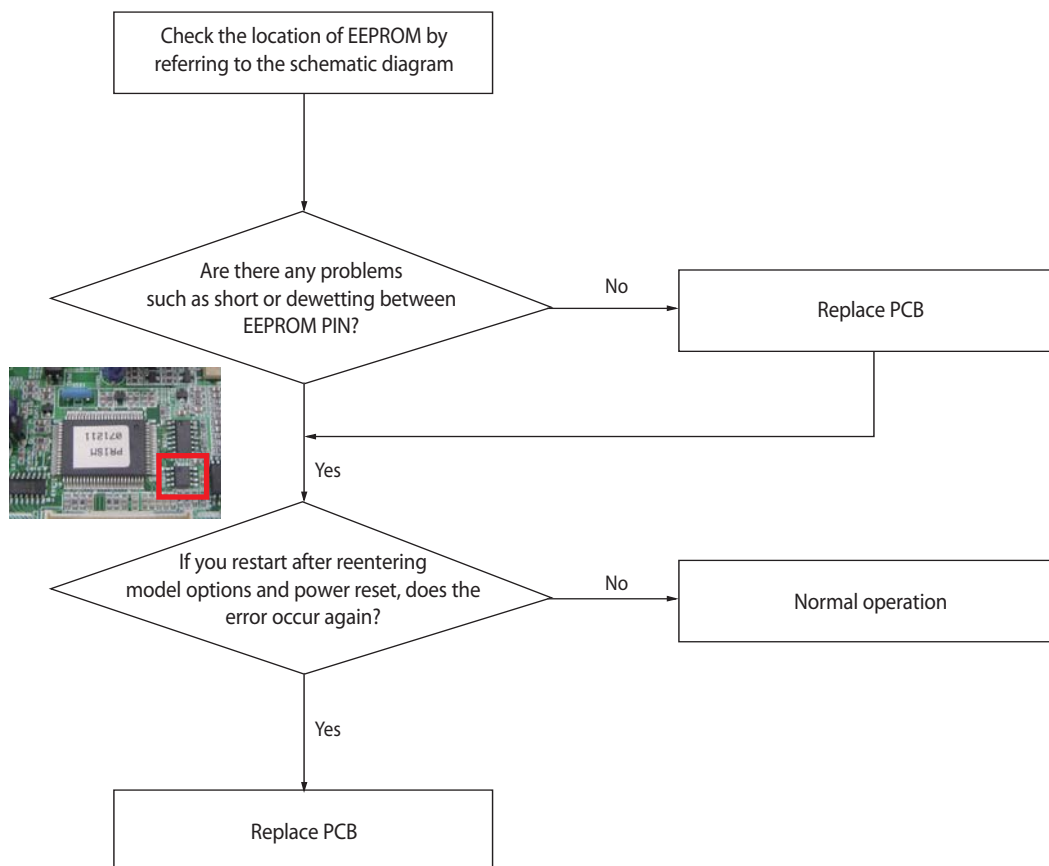

4-3-2 E653: Error due to abnormal data of Wired remote controller thermistor value

Outdoor unit display	E653 ↔ A ^x x ^x (^x x ^x : The address of the error occurred indoor unit)
Wired remote display	E653
Criteria	• Refer to how to determine below
Cause of problem	• Wired remote room thermistor has a defective OPEN/SHORT

1. How to check

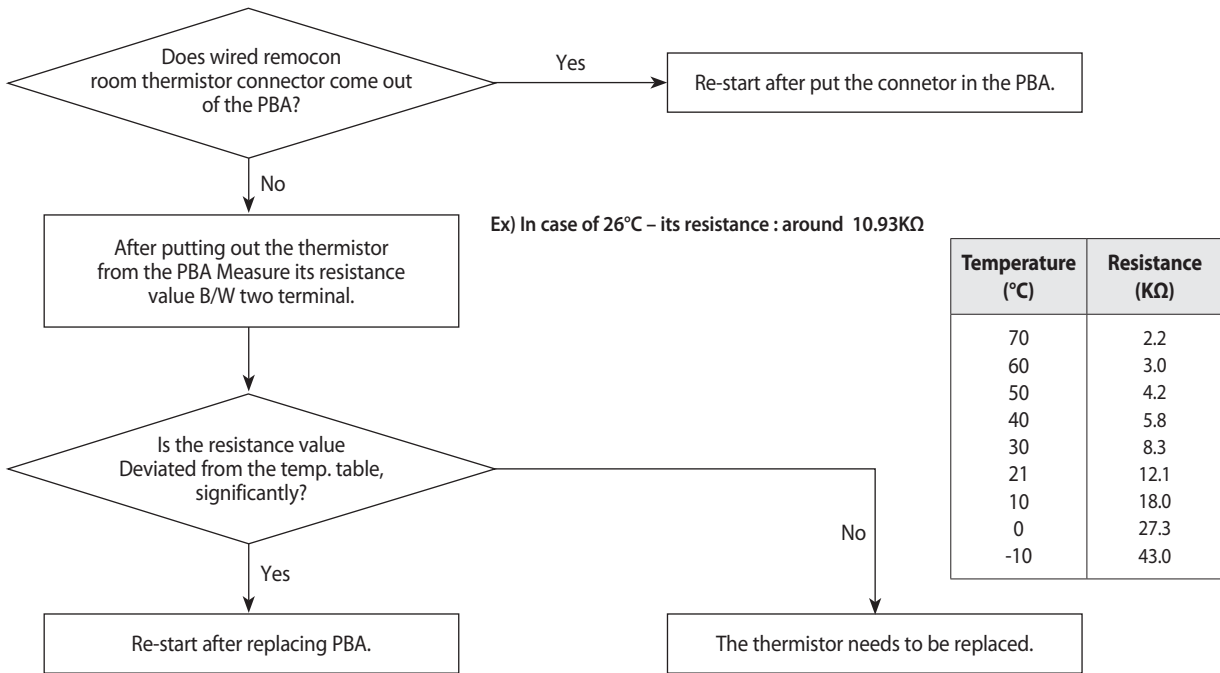

4-3-3 E903: Error due to abnormal data of Water outlet thermistor value

Outdoor unit display	E903 ↔ A _{xxxx} (_{xxxx} : The address of the error occurred indoor unit)
Wired remote display	E903
Criteria	• Refer to how to determine below
Cause of problem	• Water outlet thermistor has a defective OPEN/SHORT

1. How to check

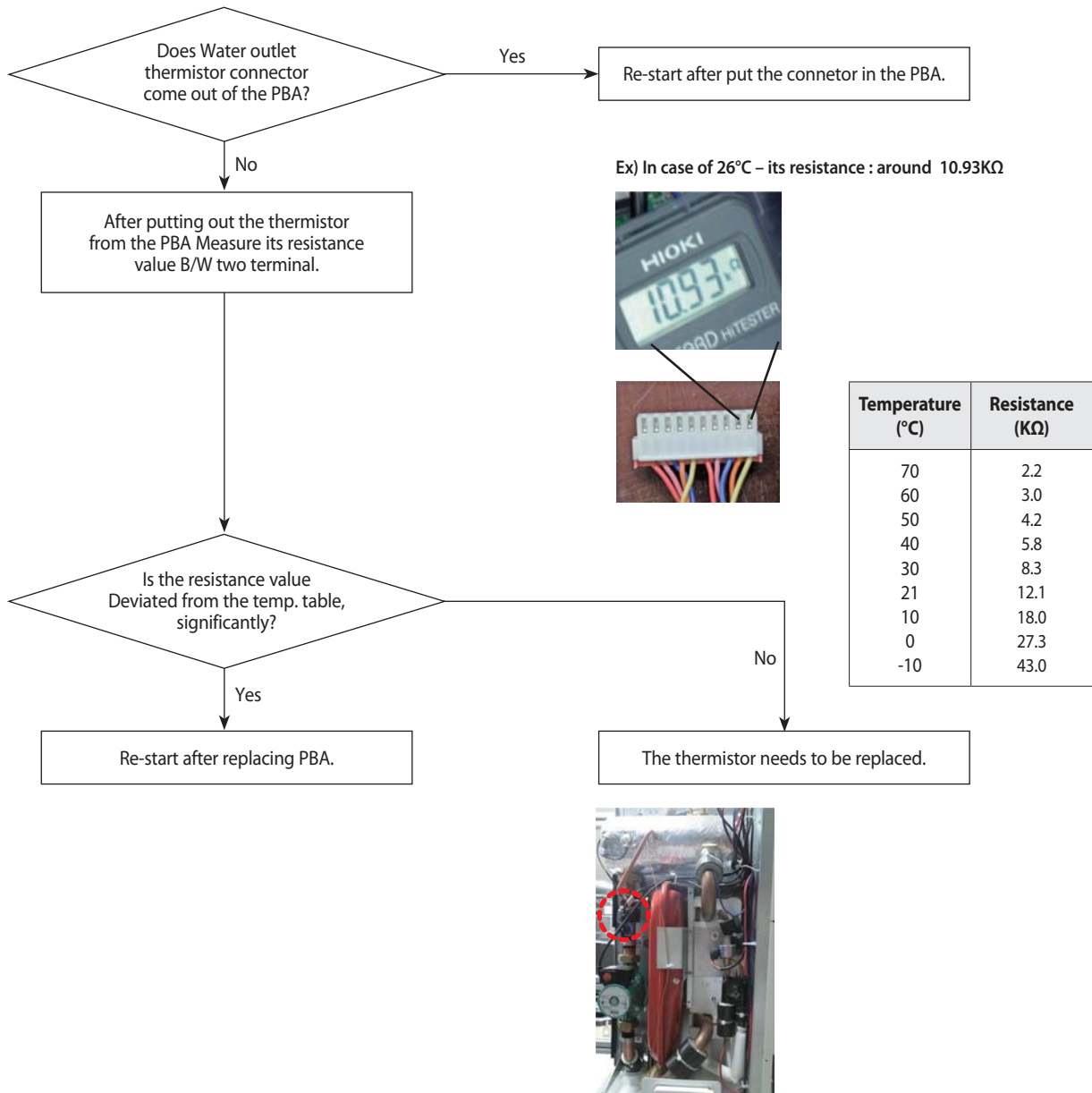

4-3-4 E904: Error due to abnormal data of DHW tank thermistor value

Outdoor unit display	E904 ← A _{xxx} (xxx: The address of the error occurred indoor unit)
Wired remote display	E904
Criteria	• Refer to how to determine below
Cause of problem	• DHW tank thermistor has a defective OPEN/SHORT

1. How to check

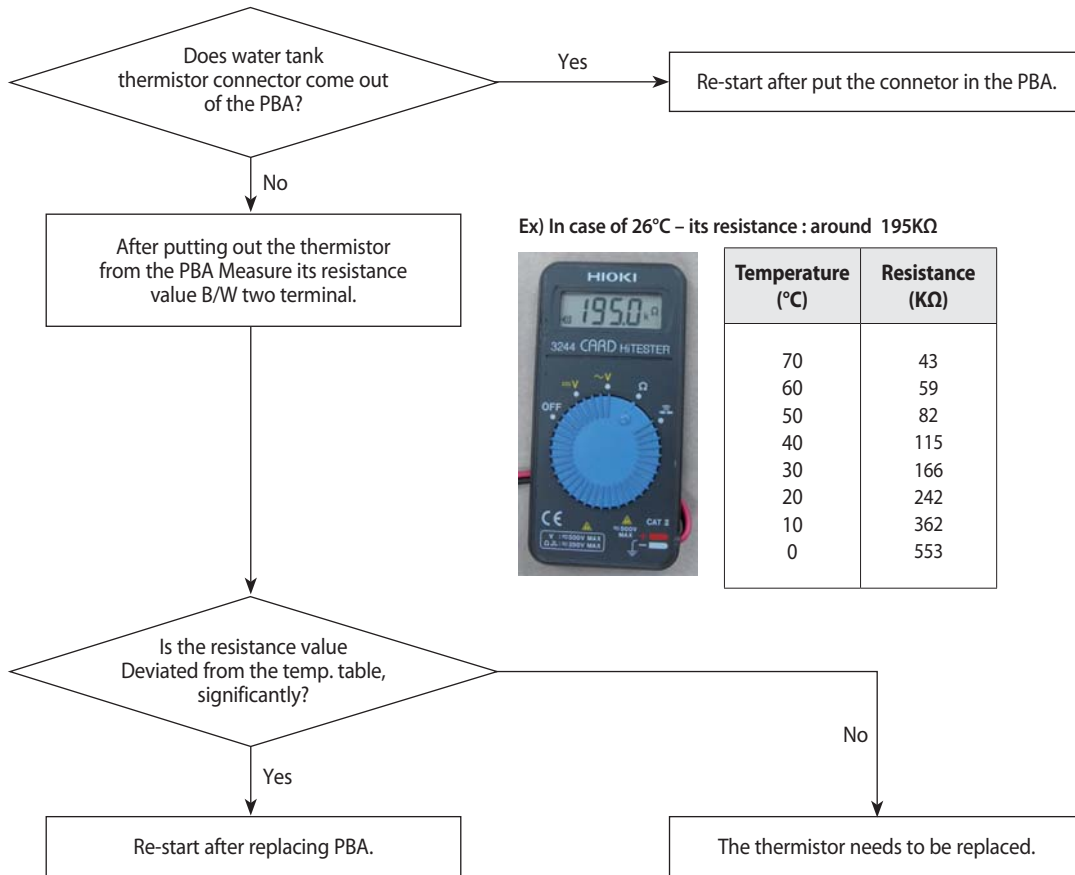

4-3-5 Water pump & flow switch OFF

Wired remote display	E911
Criteria	• Refer to how to determine below
Cause of problem	• Flow S/W OFF in 30 sec during water pump signal is ON(Starting) • Flow S/W OFF in 15 sec during water pump signal is ON (After starting)

1. How to check

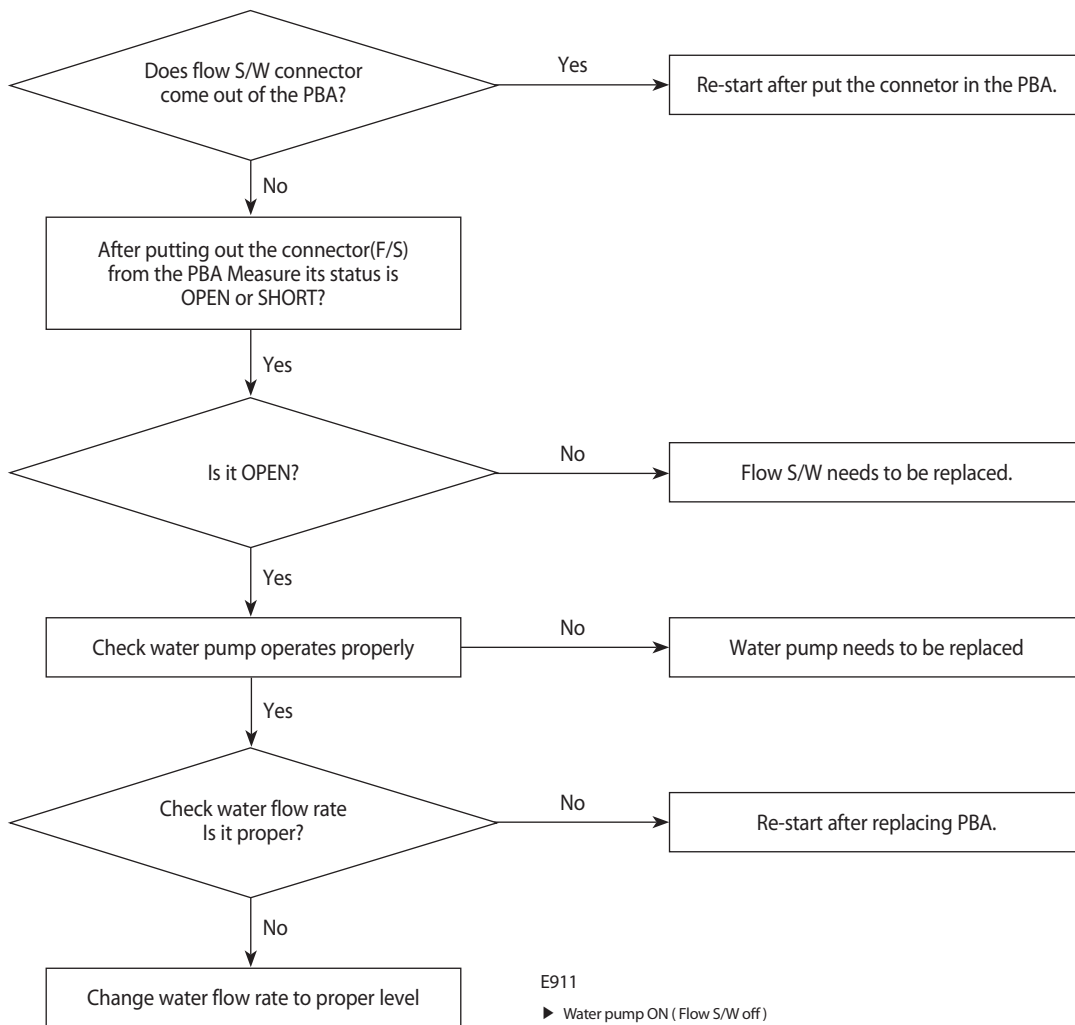

E911

▶ Water pump ON (Flow S/W off)

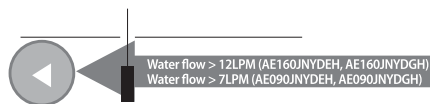

▶ Water pump ON (Flow S/W off) : NOT enough water flow

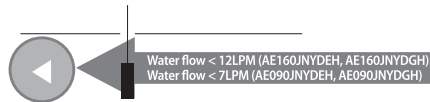

4-3-6 Water pump & flow switch ON

Wired remococon display	E9 12
Criteria	• Refer to how to determine below
Cause of problem	• Flow S/W ON in 10minutes during water pump signal is OFF.

1. How to check

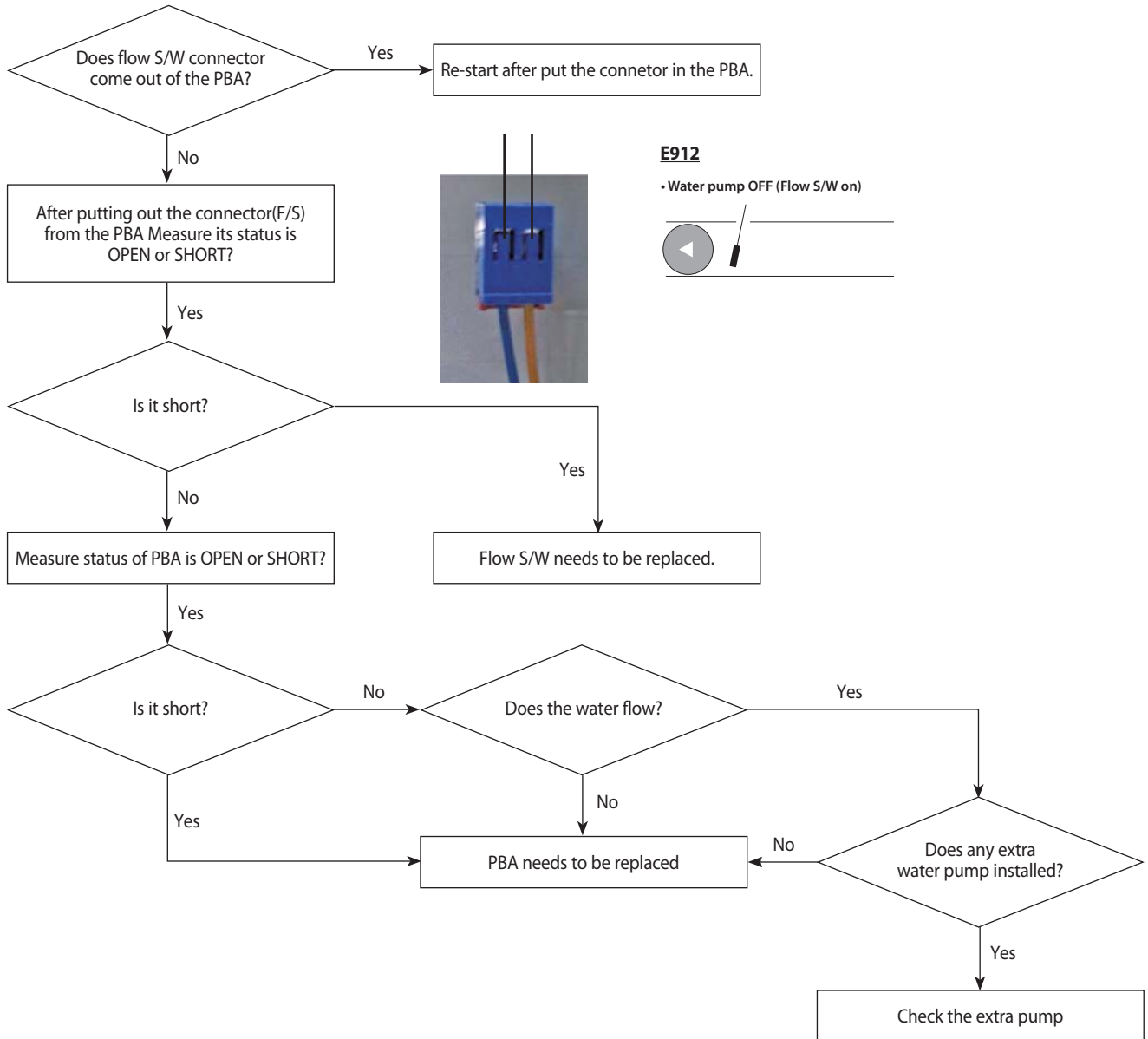

4-3-7 Hydro unit temperature sensor(open/short)

Error Mode	E901, E902, E903, E904, E906, E916
Symptom	In case of open or short circuit of indoor temperature sensor
Failure	Short or leakage of the corresponding sensor

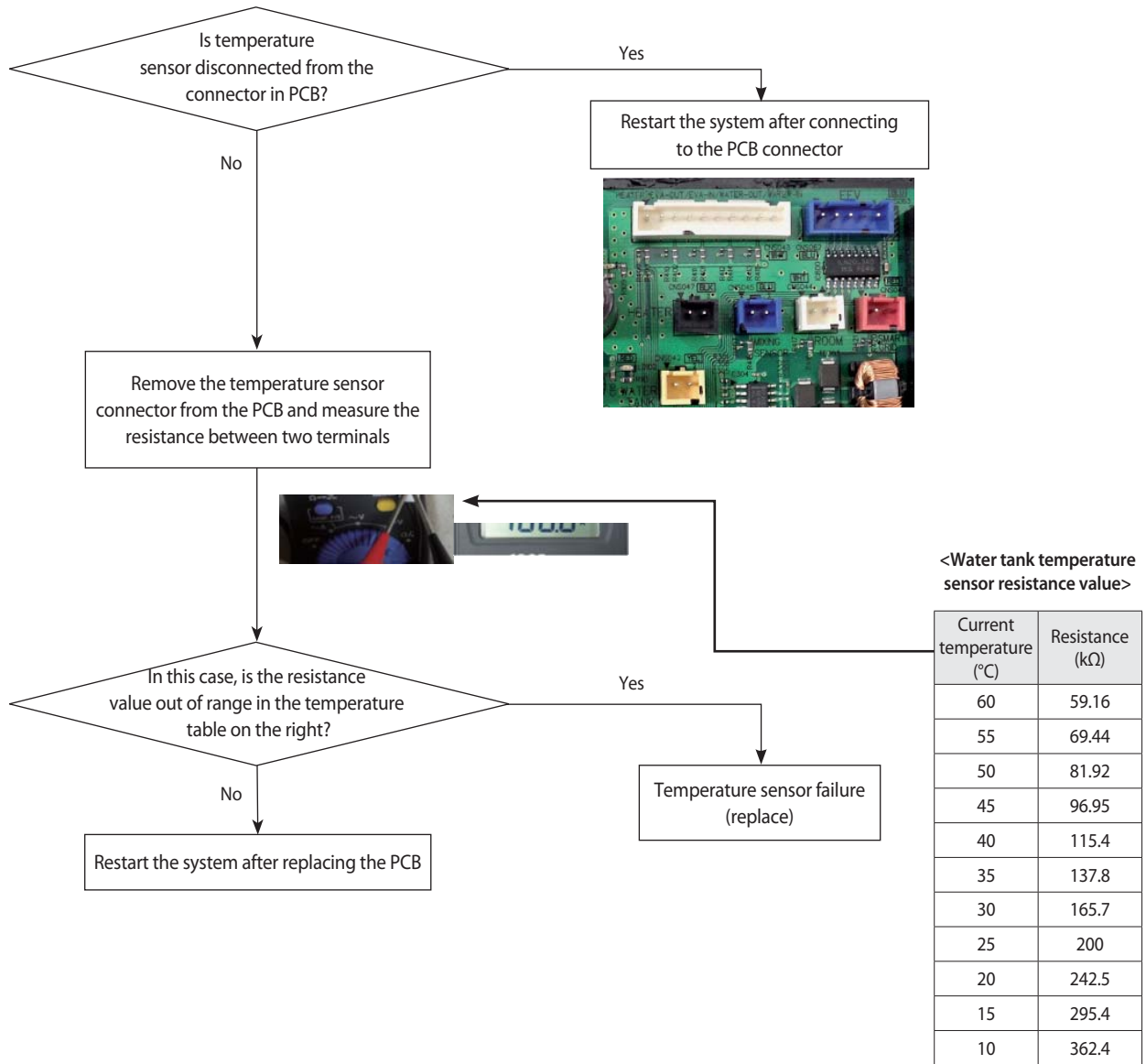

4-3-8 Communication error after finishing Tracking(Hydro unit)

Error Mode	E201, E202
Symptom	Communication error between the Hydro unit and outdoor unit for two minutes
Failure	Communication error between the Hydro unit unit and outdoor unit

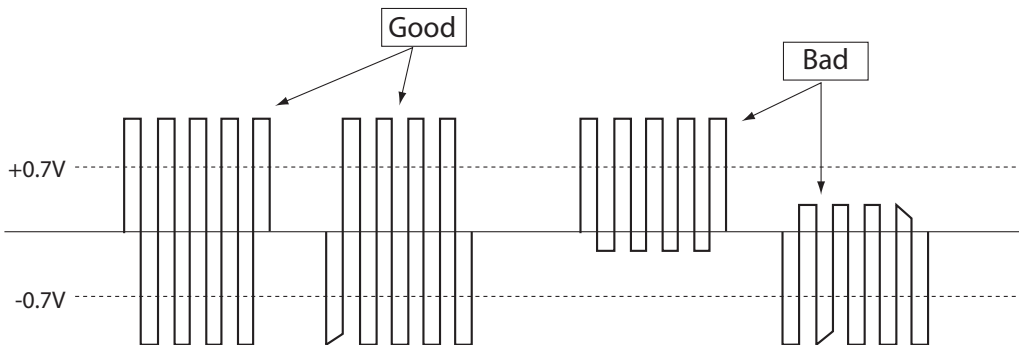
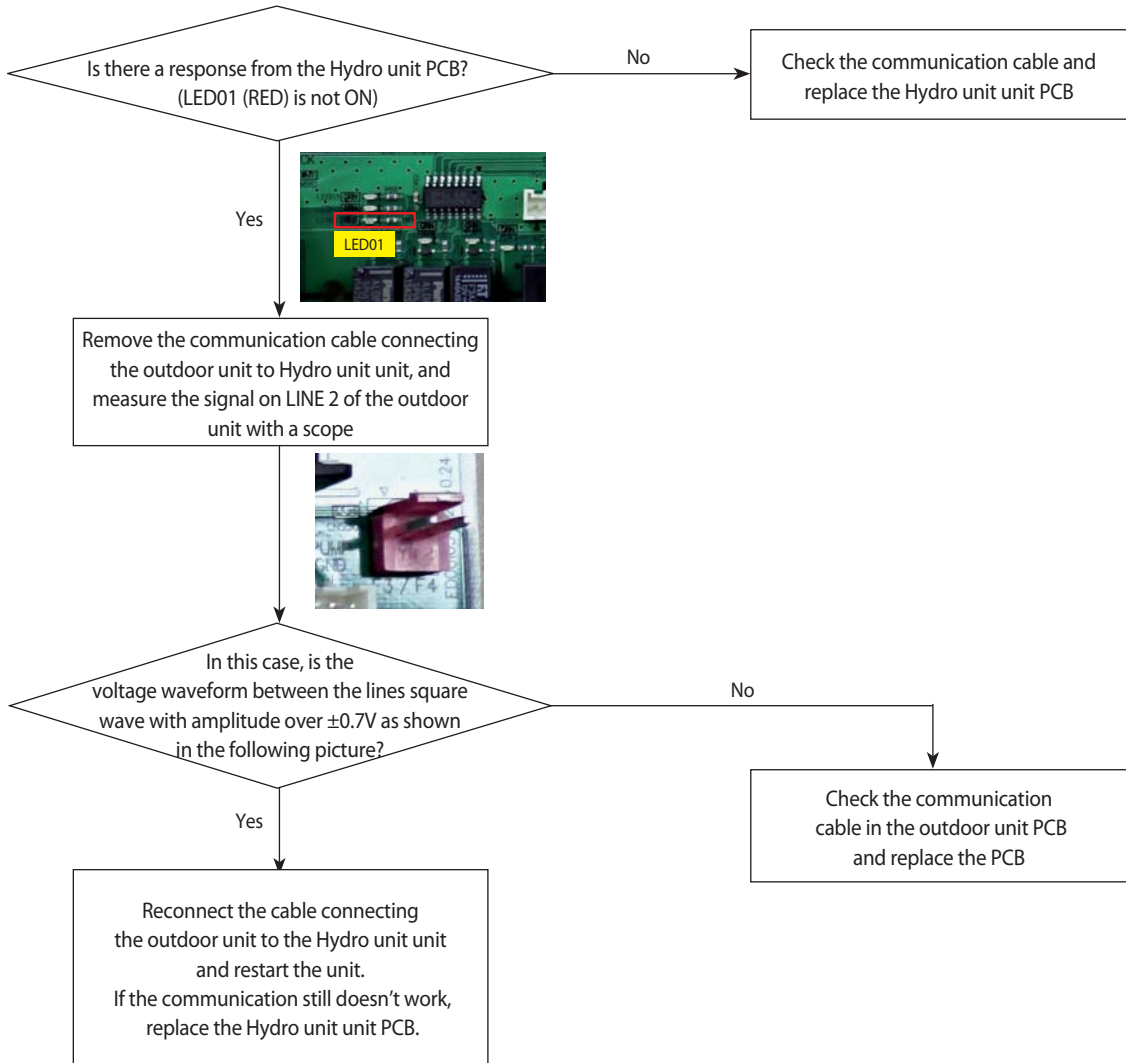

4-4 Items to check before diagnostics

4-4-1 Test run mode and view mode

Display Option Key

KEY	KEY operation	7-segment display
K1	Press once : Heating test run	"F" "1" "BLANK" "BLANK"
	Press twice : Defrost test run	"F" "3" "BLANK" "BLANK"
	Press 3times : Finishing test mode	-
K2	Press once : Cooling test run (Heating Only : skip)	"F" "2" "BLANK" "BLANK"
	Press twice : Output signal test run	"F" "4" "BLANK" "BLANK"
	Press 3 times : Finishing test mode	-
K3	Reset	-
K4	View mode	Refer to View mode display

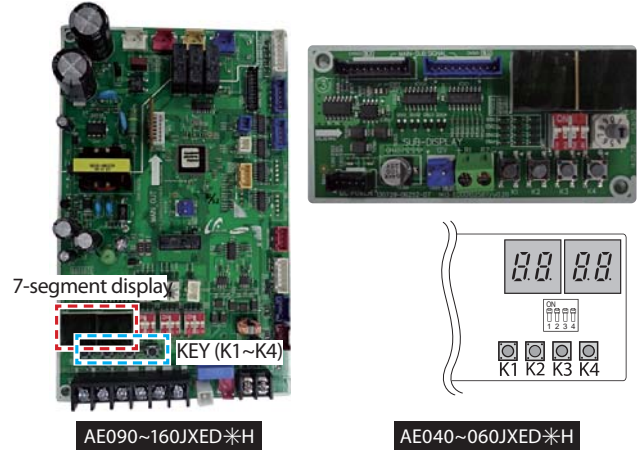

VIEW mode display

Number of press	Display contents	Display				Units
		Segment 1	Segment 2	Segment 3	Segment 4	
0	Communication State	10s digit of Tx	1s digit of Tx	10s digit of Rx	1s digit of Rx	-
1	Order frequency	1	100s digit	10s digit	1s digit	Hz
2	Current frequency	2	100s digit	10s digit	1s digit	Hz
3	Pump output	3	100s digit	10s digit	1s digit	%
4	Outdoor air sensor	4	+/-	10s digit	1s digit	°C
5	Discharge sensor	5	100s digit	10s digit	1s digit	°C
6	Eva in sensor (MONO)	6	+/-	10s digit	1s digit	°C
7	Inlet water sensor (MONO)	7	+/-	10s digit	1s digit	°C
8	Outlet water sensor (MONO)	8	+/-	10s digit	1s digit	°C
9	Cond sensor	9	+/-	10s digit	1s digit	°C
10	Current	A	10s digit	1s digit	First decimal	A
11	Fan RPM	B	1000s digit	100s digit	10s digit	rpm
12	Target discharge temperature	C	100s digit	10s digit	1s digit	°C
13	EEV	D	1000s digit	100s digit	10s digit	step
14	Protective control	E	0 : Cooling 1 : Heating	Protective control 0 : No protective control 1 : Freezing 2 : Defrosting 3 : Over-load 4 : Discharge 5 : Total current	Frequency status 0 : Normal 1 : Hold 2 : Down 3 : Up_limit 4 : Down_limit	-
15	IPM temp.	F	+/-	10s digit	1s digit	°C
long-1	Main Micom version	Year(Hex)	Month(Hex)	Day(two digit)	Day(One digit)	-
long-1 and 1	Inverter Micom version	Year(Hex)	Month(Hex)	Day(two digit)	Day(One digit)	-
long-1 and 2	EEPROM version	Year(Hex)	Month(Hex)	Day(two digit)	Day(One digit)	-

4-4-2 Troubleshooting for outdoor unit

If an error occurs during the operation, it is displayed on the outdoor unit PCB LED, both MAIN PCB and INVERTER PCB.

No.	LED Display			Displayed PCB Assy	Meaning	Remarks	Error Code
	Red	Green	Yellow				
-	●	◎	○	MAIN/INVERTER	Normal operation (MAIN : Indoor↔ Outdoor : Green ON) (INVERTER : MAIN PCB↔ INVERTER PCB : Green ON)		-
1	●	◎	○	MAIN	Hydro unit quantity is mismatched.	Check Hydro unit quantity setting in outdoor	E201
2	●	●	○	MAIN/INVERTER	Abnormal state, no communication between Indoor and Outdoor Main PCB	Check electrical connection and setting	E202
	▮	○	○				
4	●	●	◎	MAIN/INVERTER	1min. Time out of communication error(Main↔ Inverter)	Check electrical connection and setting	E203
5	●	◎	○	MAIN	Outdoor temp sensor error	Check Outdoor sensor Open/Short	E221
6	●	◎	○	MAIN	Cond. temp sensor error	Check Cond. sensor Open/Short	E231
7	●	◎	○	MAIN	Discharge temp sensor error	Check Discharge sensor Open/Short	E251
8	●	◎	○	MAIN	OLP Sensor Error	Check OLP sensor Open/Short	E320
9	●	◎	○	MAIN	Detection of Outdoor Freezing when Comp. Stop	Check Outdoor Cond.	E403
10	●	◎	○	MAIN	Protection of Outdoor Overload when Comp. Stop	Check Comp. when it start	E404
11	●	◎	○	MAIN	Discharge temperature of a compressor in an outdoor unit is overheated.		E416
12	●	◎	○	MAIN	Outdoor EEV Open error	Check EEV	E419
13	●	◎	○	MAIN	Miss wiring error at 3Phase power source line (Only 3Phase Model)	Check Power Line-R,S,T,N	E425
14	●	◎	○	MAIN	Gas leakage error (Stop state)	Check Gas leak	E439
15	●	◎	○	MAIN	Heating operation is not available since the outdoor air temperature is over 35°C.	Heating	E440
					16	Cooling	E441
16	●	◎	○	MAIN	Gas leakage error (Before operating)	Check Gas leak	E443
17	○	○	●	MAIN/INVERTER	Outdoor unit BLDC Fan 1 or Fan 2 error	FAN1 error	E458
						19	E475
18	○	◎	○	MAIN/INVERTER	Comp. Starting error		E461
19	●	◎	○	MAIN	Primary Current Trip error		E462
20	●	◎	○	MAIN	Over current trip / PFC over current error	Check OLP sensor	E463
21	◎	○	○	MAIN/INVERTER	IPM(IGBT Module) Over Current(O.C)		E464
22	○	●	◎	MAIN/INVERTER	Comp. Over load error		E465
23	◎	●	○	MAIN/INVERTER	DC-Link voltage under/over error	Check AC Power or DC_Link voltage	E466

○ Off ◎ Blink ● On

Troubleshooting for outdoor unit(con.)

If an error occurs during the operation, it is displayed on the outdoor unit PCB LED, both MAIN PCB and INVERTER PCB.

No.	LED Display			Displayed PCB Assy	Meaning	Remarks	Error Code
	Red	Green	Yellow				
24	●	○	●	MAIN/INVERTER	Comp. wire missing error	Check Comp. wire	E467
25	●	◎	◎	MAIN/INVERTER	Current sensor error	Check Outdoor Inverter PBA	E468
26	●	◎	○	MAIN	DC-Ling voltage Sensor error	Check Input voltage	E469
27	●	◎	○	MAIN	EEPROM read/write error	Check EEPROM	E470
28	●	◎	○	MAIN	Outdoor EEPROM error	Check Outdoor EEPROM date	E471
29	◎	◎	○	MAIN/INVERTER	IPM(IGBT Module) or PFCM Temperature sensor Error	Check Outdoor Inverter PBA	E474
30	●	◎	●	MAIN/INVERTER	PFC Overload Error	Check Outdoor Inverter PBA	E484
31	●	◎	○	MAIN	Input current sensor error		E485
32	◎	◎	○	MAIN/INVERTER	IPM is over heated.	Check Outdoor Inverter PBA	E500
33	●	◎	○	MAIN	GAS Leak error	Check indoor and outdoor unit model	E554
34	●	◎	○	MAIN	Water inlet temperature sensor error	Check Water inlet sensor	E901
35	●	◎	○	MAIN	Water outlet temperature sensor error	Check Water outlet sensor	E903
36	●	◎	○	MAIN	Refrigerant gas inlet temperature sensor error	Check Gas inlet sensor	E906
37	●	◎	○	MAIN	Mixing Valve Outlet temperature sensor error	Check Mixing Valve Outlet sensor	E916

○ Off ◎ Blink ● On

4-5 Troubleshooting by symptoms

4-5-1 Communication error after finishing tracking (E202)

1. Check items
 - 1) Is the communication cable short/open?
 - 2) Is there a response from the Hydro unit PCB?
2. Check procedure

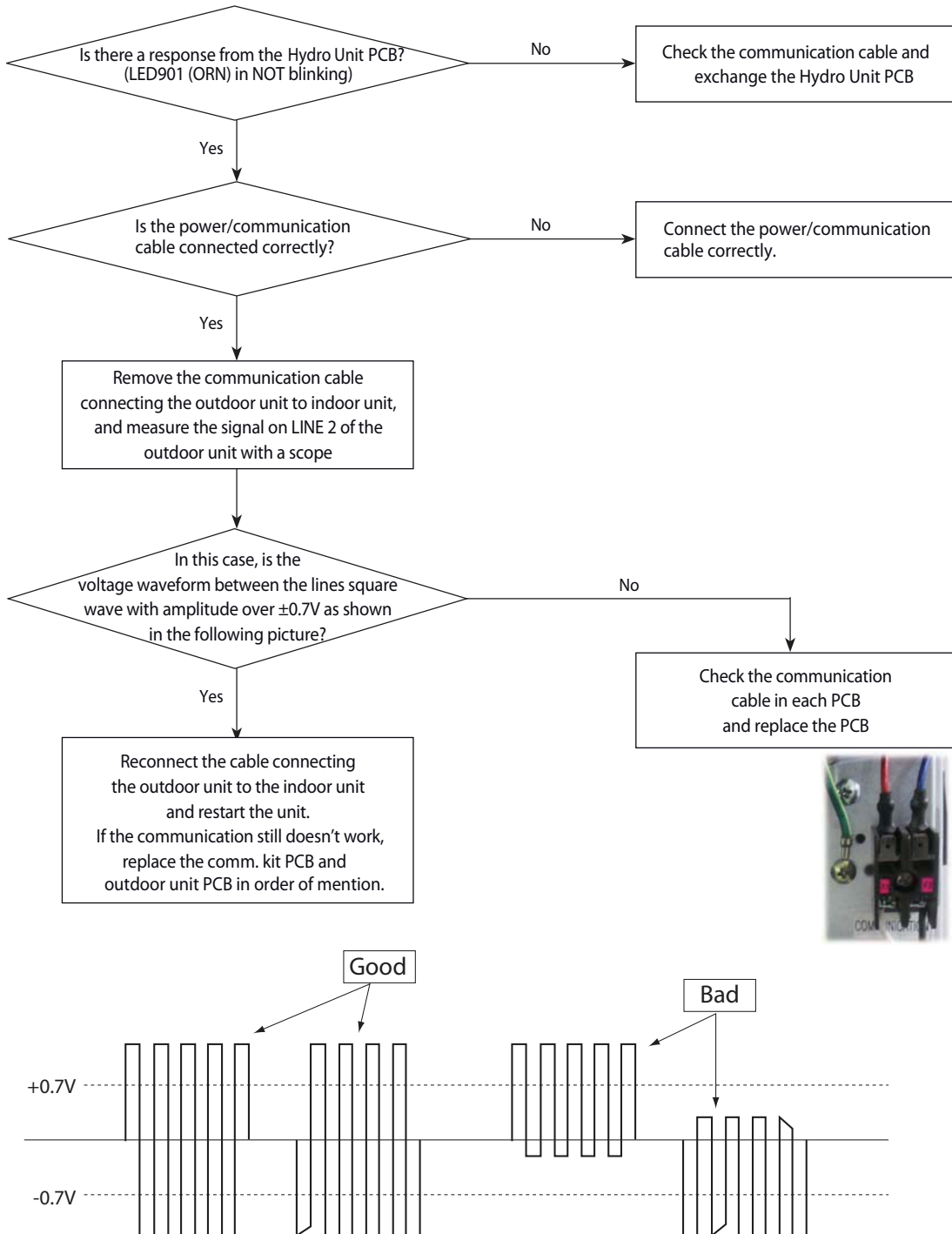

cf.) If there is no oscillo scope, it can be replaced multimeter instead of osillo scope.
If measured voltage is floating value from 0.1V to 4.5V, then it means that the PCB is normal.

4-5-2 Time out (1 min.) of communication error between MAIN PBA and INV. PBA (E203)

1. Check items
 - 1) Is the communication cable connected properly between MAIN PBA and INVERTER PBA?
 - 2) Is the power cable connected correctly?
2. Check procedure

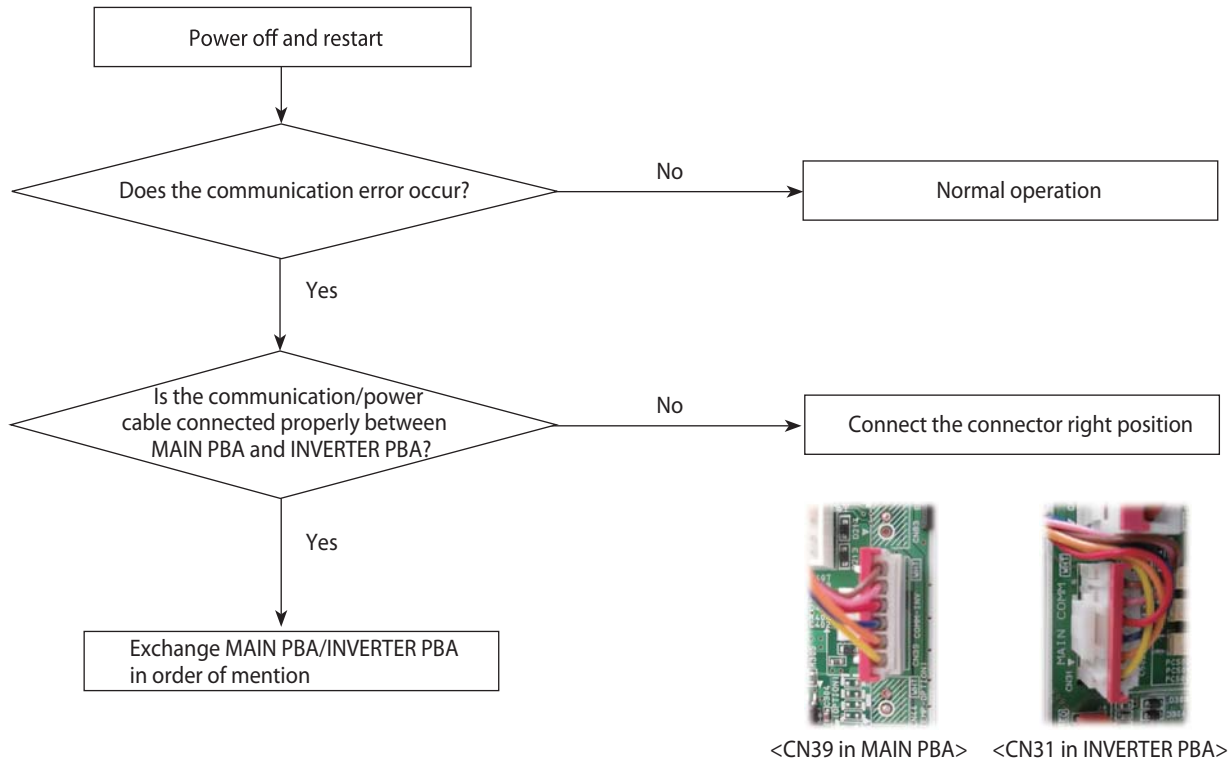

4-5-3 Temperature sensor error (E221, E231, E251, E320)

<Error code for each temperature sensor>

CN43 in MAIN PBA	Pin no.	Temp. sensor	Error code
	1,2	Outdoor	E221
	3,4	Condenser	E231
	5,6	Discharge	E251
	7,8	OLP	E320

1. Check items

- 1) Is the sensor connected correctly (CN43 in MAIN PBA)?
- 2) Is the position of sensor correct?
- 3) Does the value of resistance satisfy the each temperature condition?

2. Check procedure

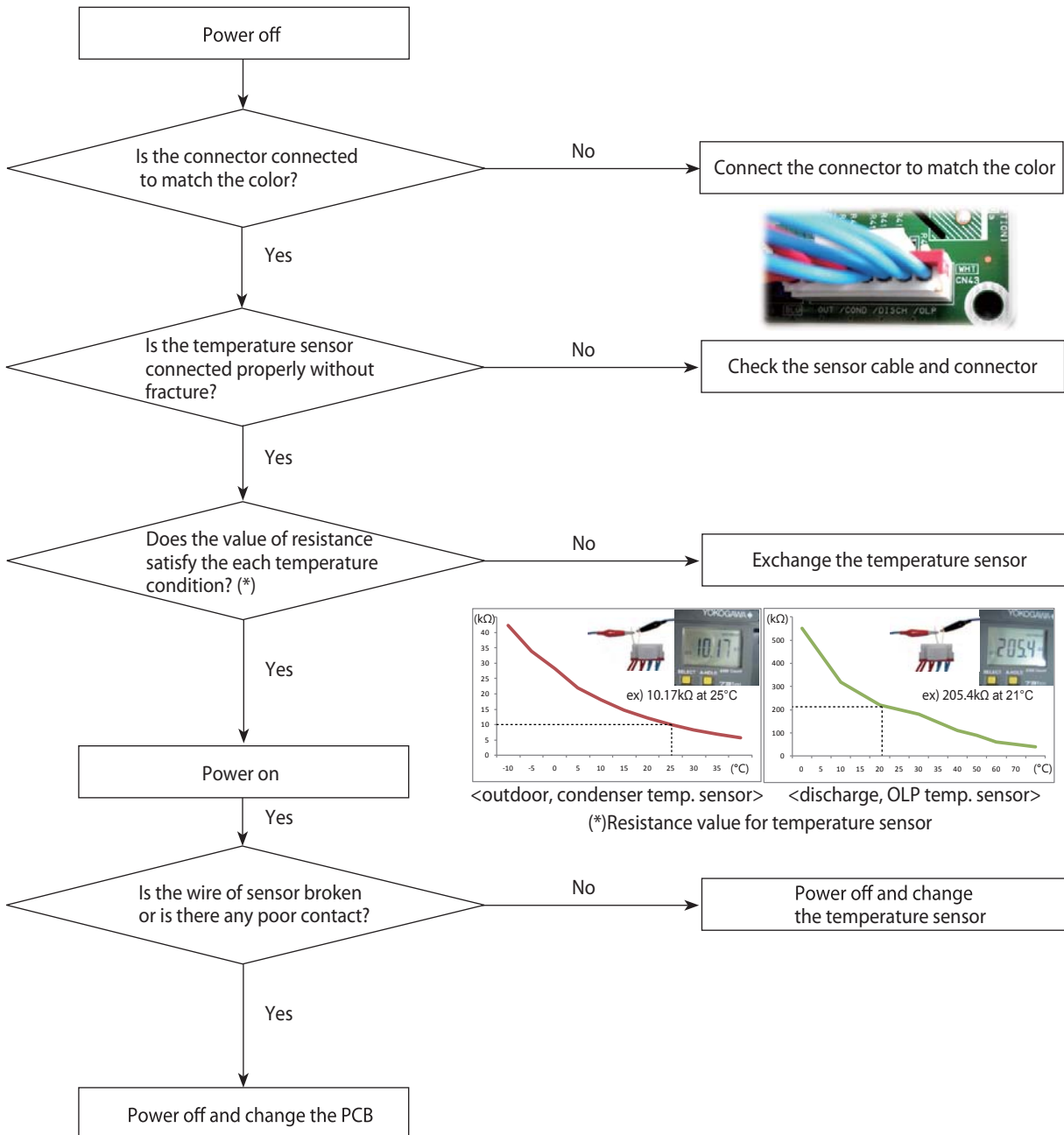

4-5-4 Fan error (E458, E475)

FAN 1 error(E458), FAN 2 error(E475)

1. Check items
 - 1) Are the input power voltage and power connection correct?
 - 2) Is the motor wire connected to the outdoor PCB correctly?
 - 3) Is there no obstacle at the surrounding of motor and propeller?
 - 4) Does the driver in the motor case broken?
2. Check procedure

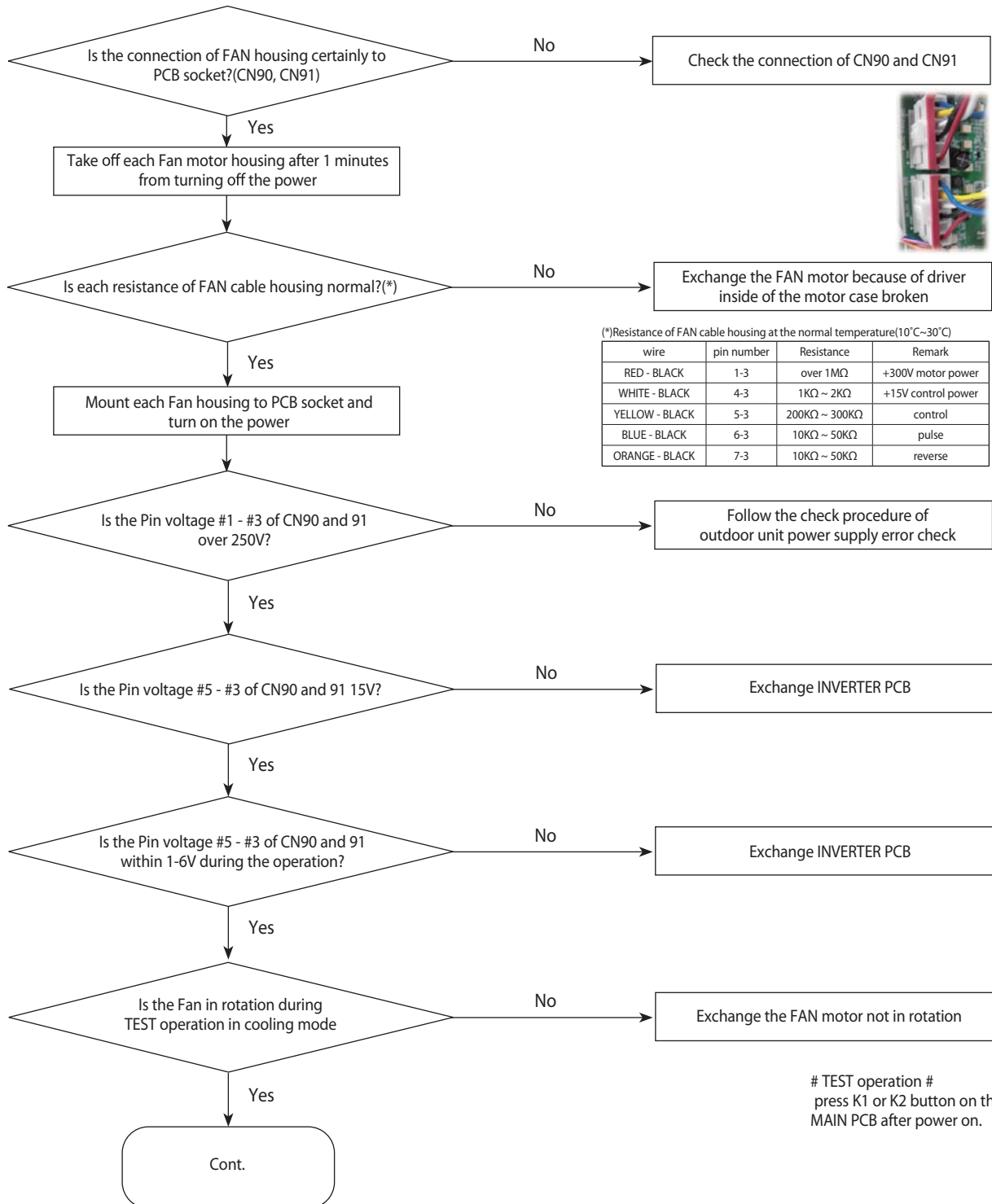

Fan error (E458, E475) (cont.)

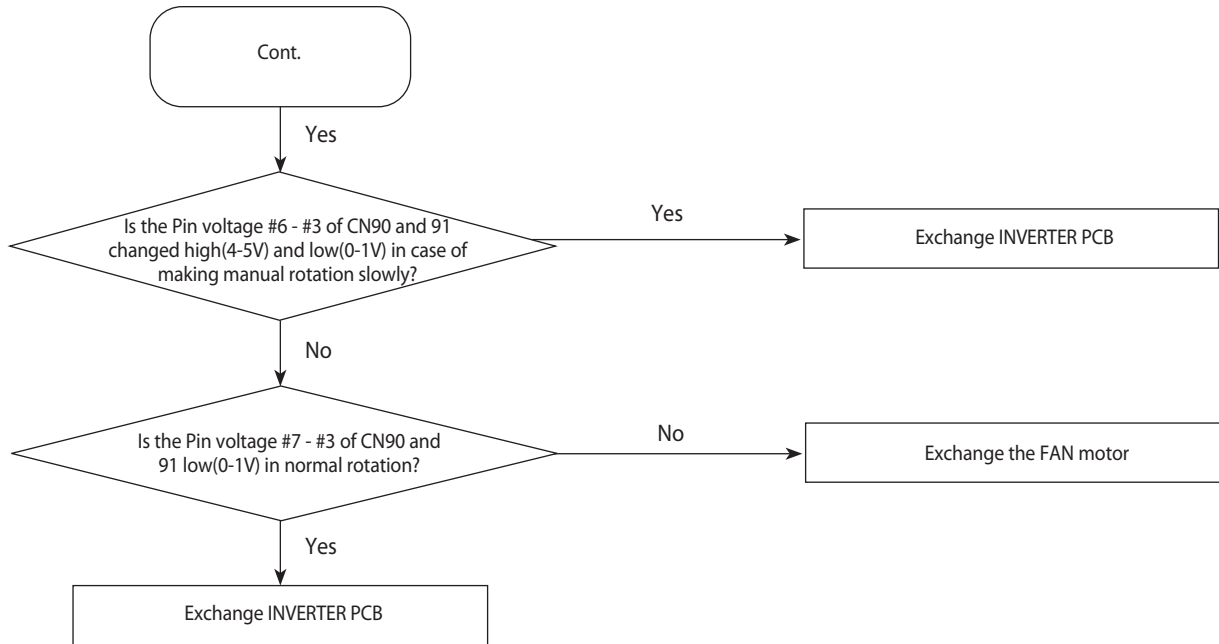

4-5-5 Compressor error (E461, E467)

Compressor starting error(E461), Compressor wire missing error(E467)

1. Check items
 - 1) Is the power connected properly?
 - 2) Is the connector of compressor connected correctly?
 - 3) Is the resistance normal between each phase for compressor ?
2. Check procedure

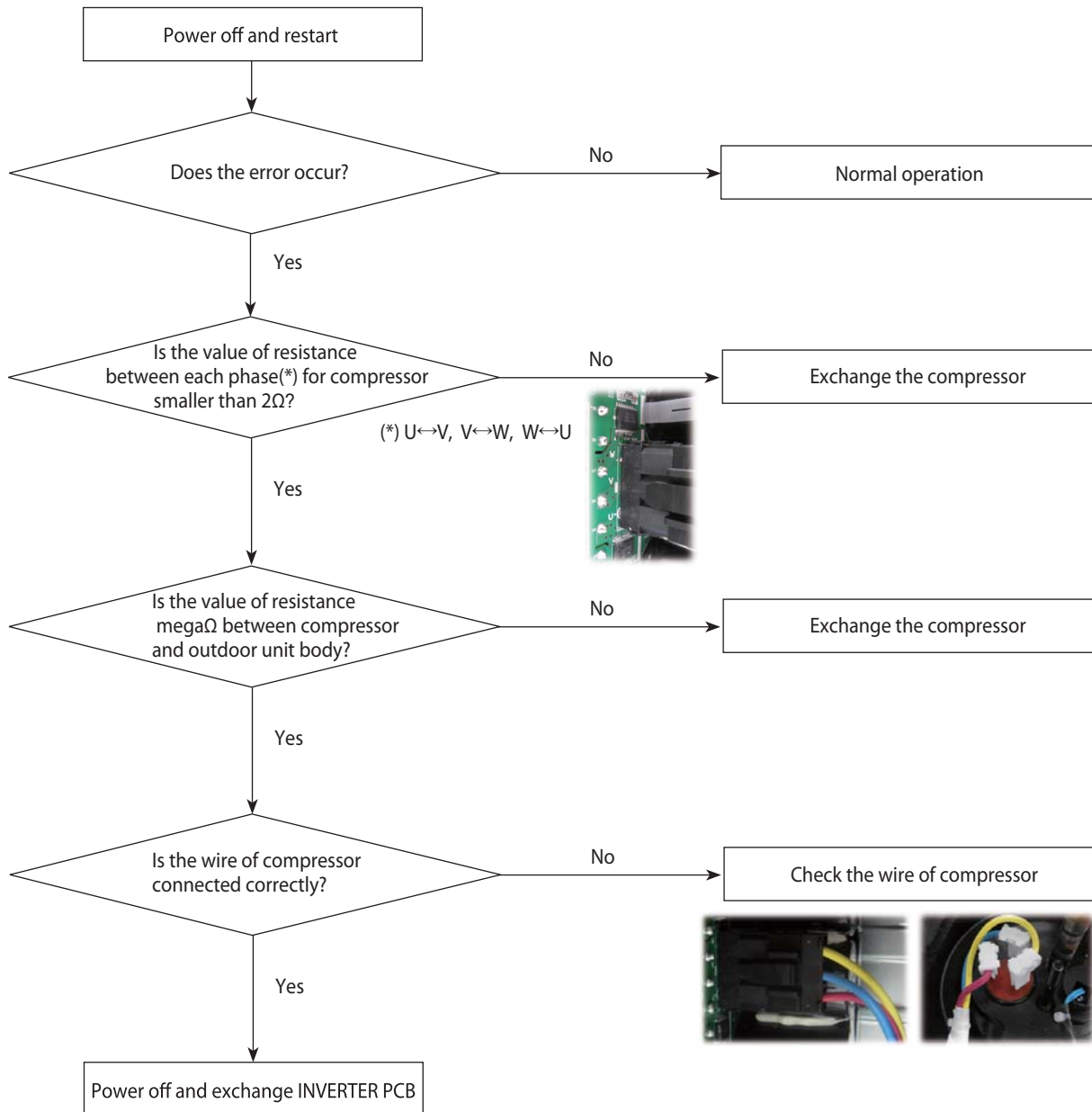

4-5-6 Current trip error (E462, E463)

Primary current trip error(E462), Over current trip / PFC over current error(E463)

1. Check items

- 1) Is the voltage of power suitable?
- 2) Is refrigerant charged?
- 3) Does the fan of outdoor unit work normally?
- 4) Is there any obstacle around indoor and outdoor unit?

2. Check procedure

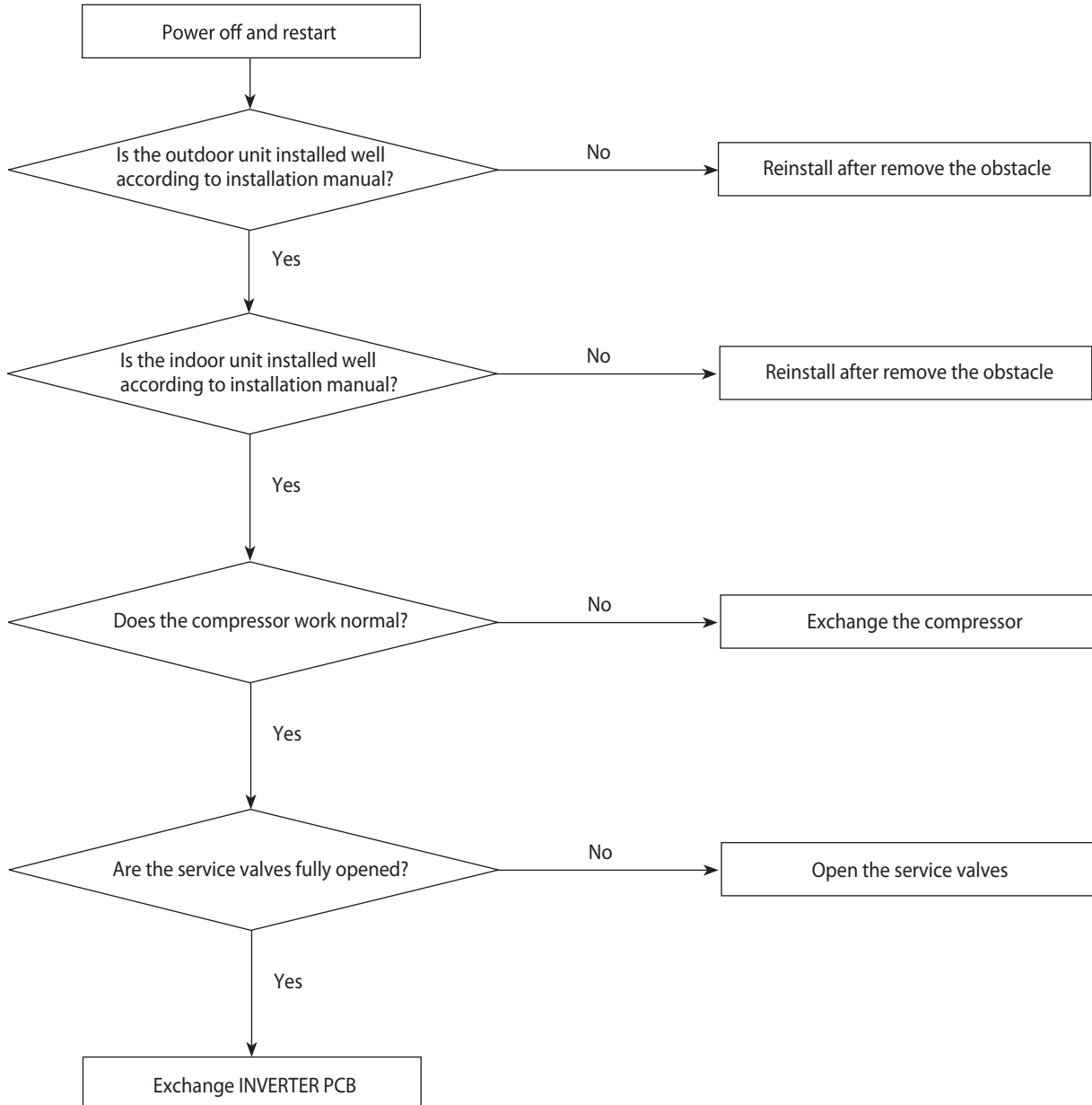

4-5-7 IPM(IGBT module) over current error (E464)

1. Check items
 - 1) Is refrigerant charged?
 - 2) Does the compressor work normally?
 - 3) Is the connection of compressor correctly?
 - 4) Is there any obstacle around indoor and outdoor unit?

2. Check procedure

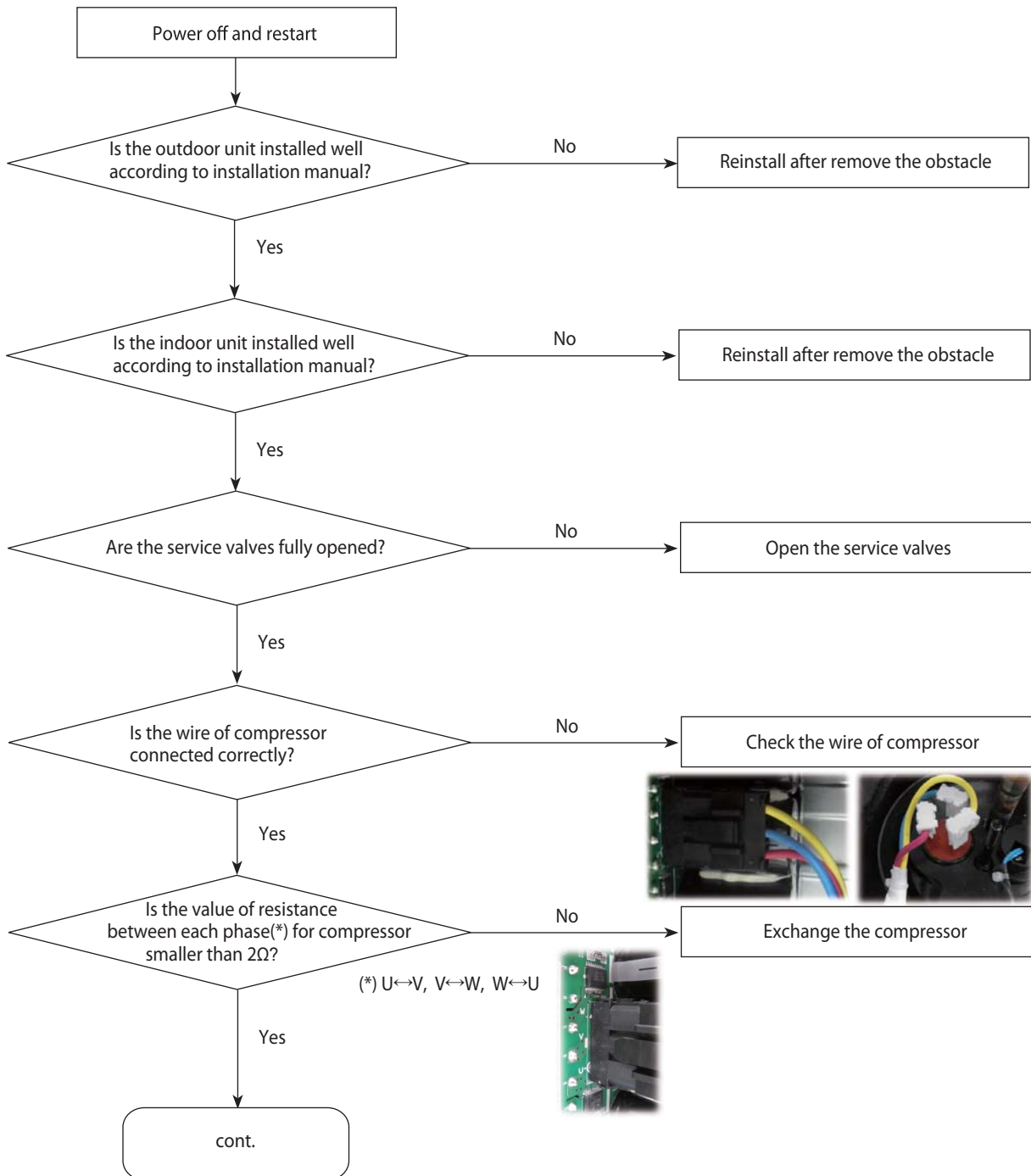

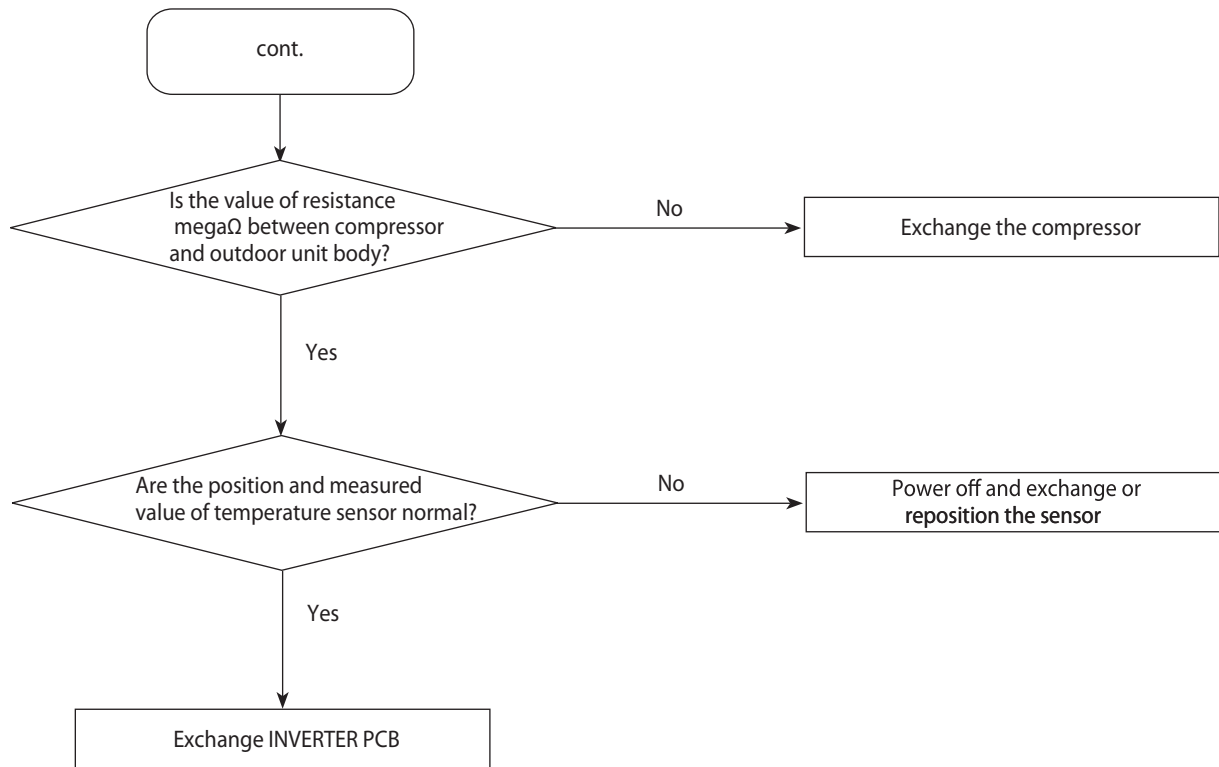

4-5-8 DC-link voltage under/over error (E466)

1. Check items
 - 1) Is the input power normal?
 - 2) Is the AC power connected correctly?
2. Check procedure

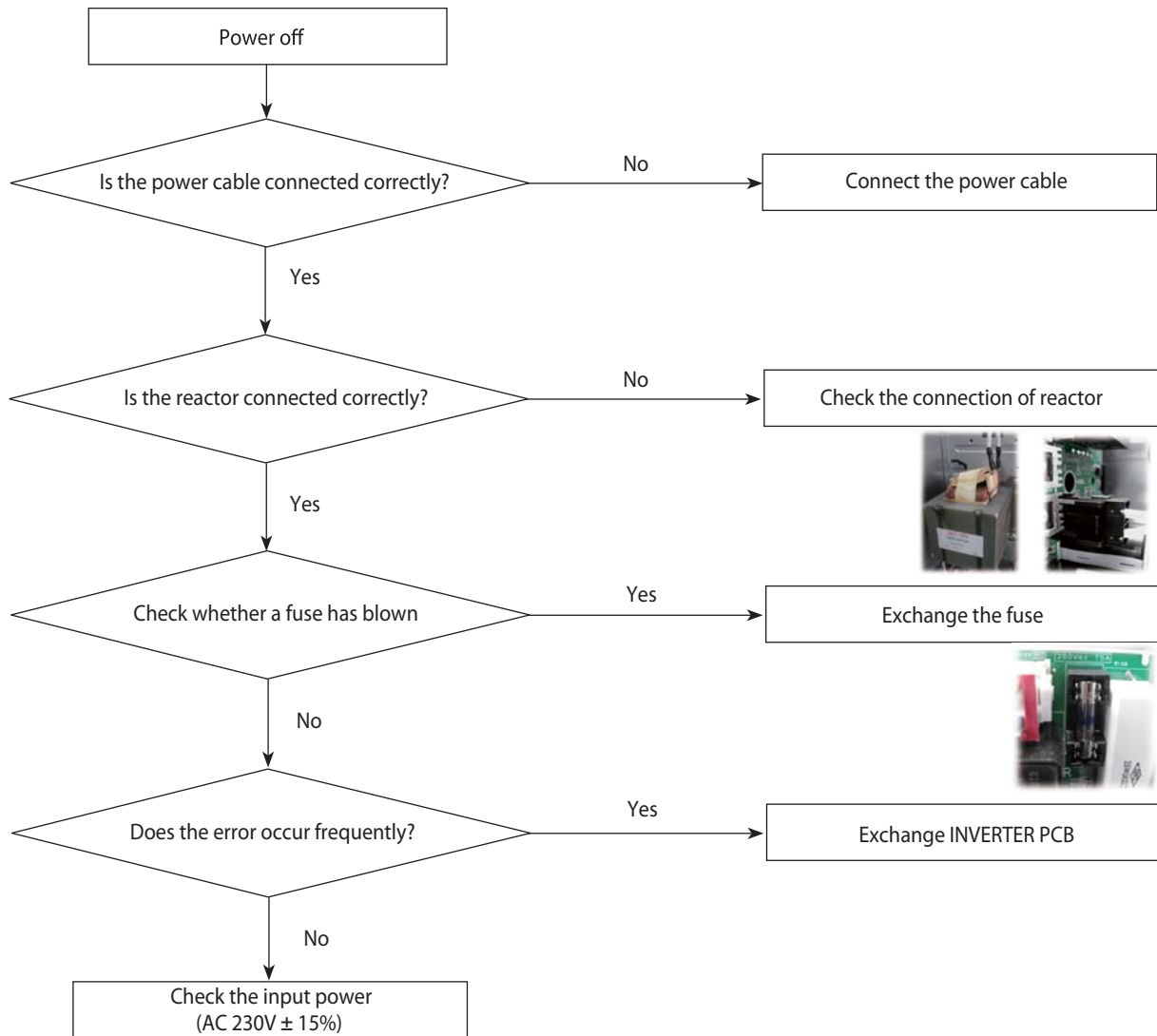

4-5-9 GAS leak error(E554)

1. Check items

- 1) Is refrigerant charged?
- 2) Is the evaporator sensor of indoor unit connected correctly?

2. Check procedure

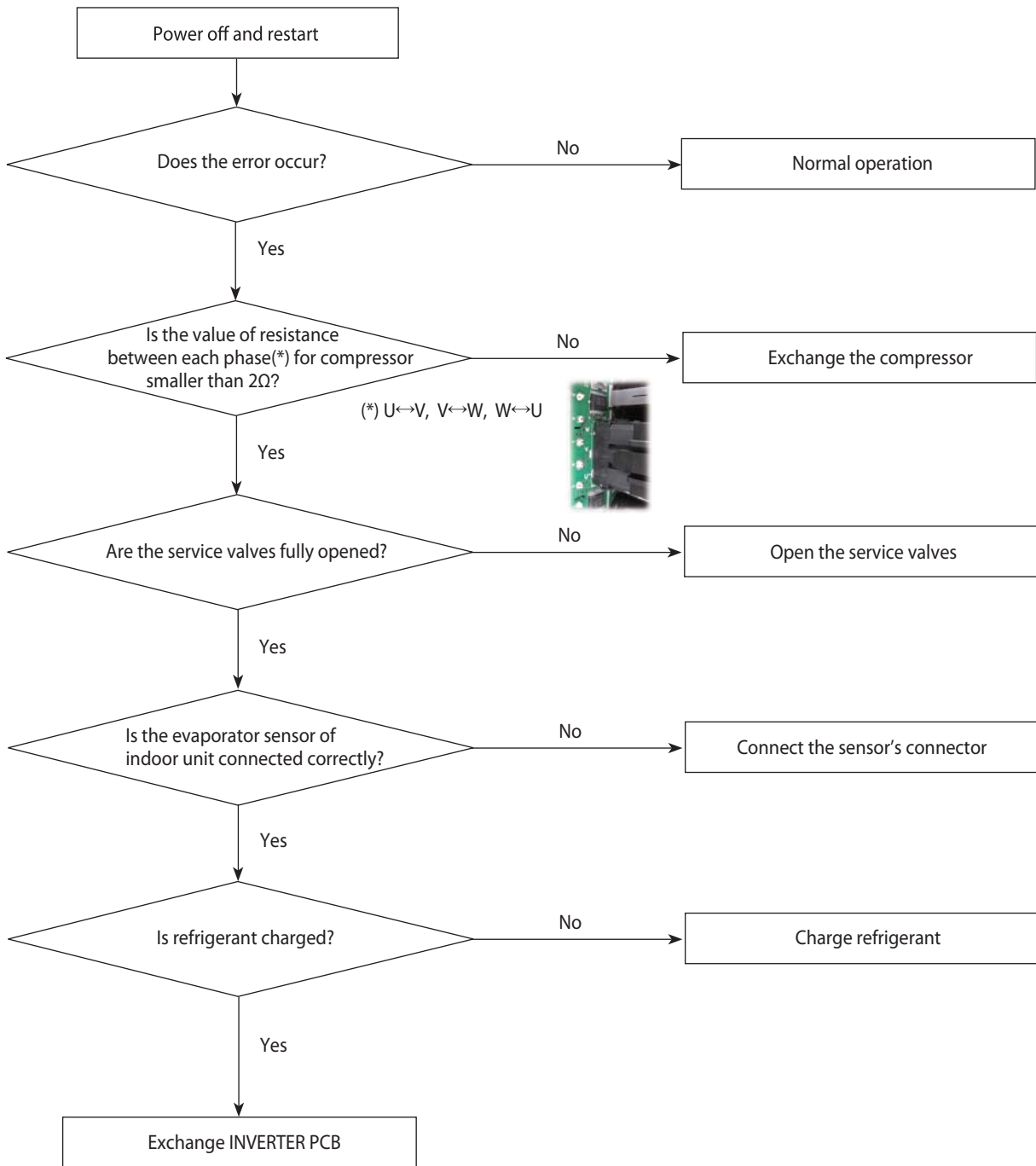

4-5-10 The other errors

Error code	Meaning	Troubleshooting
E177	Emergency stop	Indoor unit (Hydro Unit) orders emergency stop. Check the indoor unit (Hydro Unit).
E201	Hydro Unit quantity is mismatched.	Hydro Unit quantity must be matched with outdoor unit 1 by 1. Check the Hydro Unit quantity. It must be 1EA.
E403	Detection of outdoor freezing when compressor stops.	Outdoor unit (Condenser) froze. Check condenser.
E404	Protection of outdoor overload when compressor stops.	Compressor is overloaded. Please check same as E461 and check compressor when it starts.
E416	Discharge temperature of a compressor in an outdoor unit is overheated.	Discharge temperature is overheated.
E440	Heating operation is not available since the	Check the outdoor temperature.
E441	Cooling operation is not available since the outdoor air temperature is lower than -15°C.	
E465	Compressor over load error	Compressor is overloaded. Please check same as E461 and check compressor when it starts.
E468	Current sensor error	Exchange INVERTER PBA.
E471	Outdoor EEPROM error	EEPROM date is wrong. Exchange EEPROM or MAIN PBA. This error don't occur in EMF 150-AM)
E474	IPM(IGBT Module) or PFCM temperature sensor error	Exchange INVERTER PBA.
E484	PFC overload error	Check reactor located in control plate. If reactor is normal, exchange INVERTER PBA.
E500	IPM is over heated.	Check INVERTER PBA's temperature. Power off and cool down INVERTER PBA, and then restart the outdoor unit.
E556	Capacity mismatching between indoor and outdoor.	EEPROM data is wrong. Exchange EEPROM or MAIN PBA
E557	Option code miss matching among the indoors(only for DPM)	Option setting data is wrong. (This error don't occur in EMF 150-AM)

4-5-11 In case of heating at the cooling mode or cooling at the heating mode

1. Troubleshooting procedure

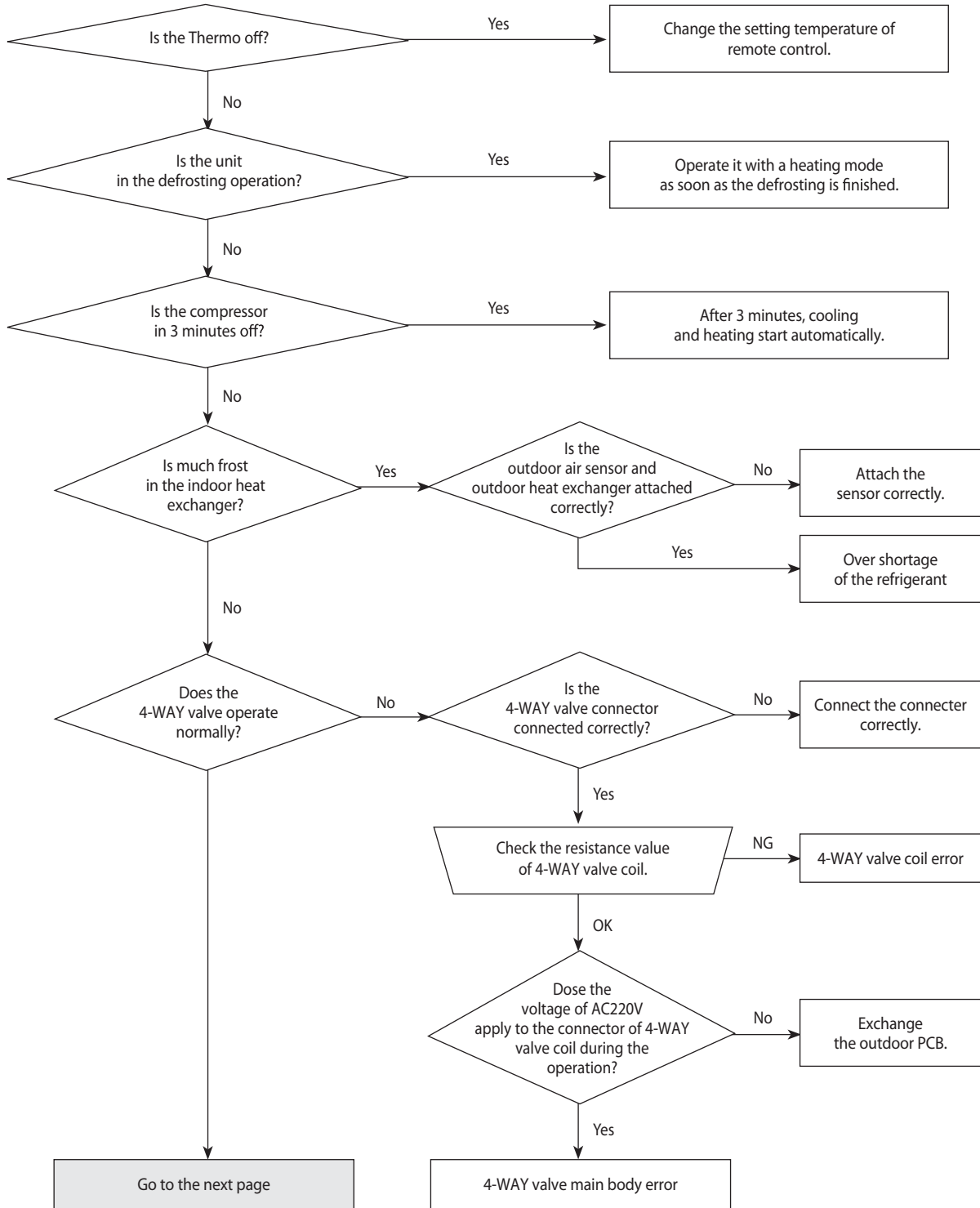

* Normal resistance value of 4 way valve coil : $1.5 \pm 0.15k\Omega$ (at 20°C)

In case of heating at the cooling mode or cooling at the heating mode (cont.)

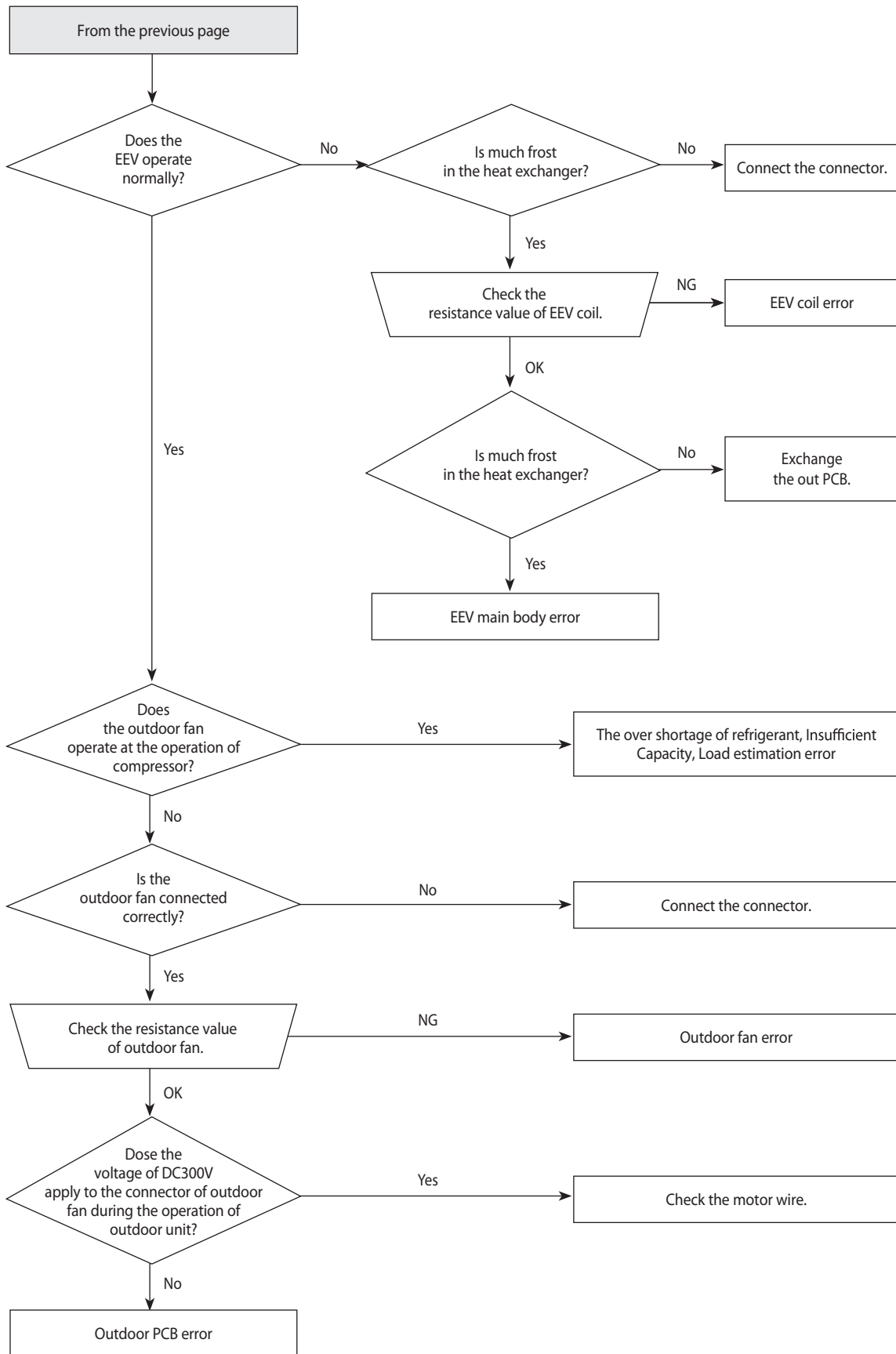

* Normal resistance value of EEV valve coil(Red-Black or Yellow-Orange) : $92 \pm 8\Omega$ (at 20°C)

4-5-12 Outdoor unit is not powered on – Initial diagnosis

1. Check items
 - 1) Is the power supply voltage 380V?
 - 2) Is the AC power connected correctly?
 - 3) Are the LEDs in the main PCB and inverter PCB of the outdoor unit ON?
 - 4) Is the input power voltage of the indoor unit 220V?
 - 5) Is the wired remote controller connected correctly?
2. Check procedure

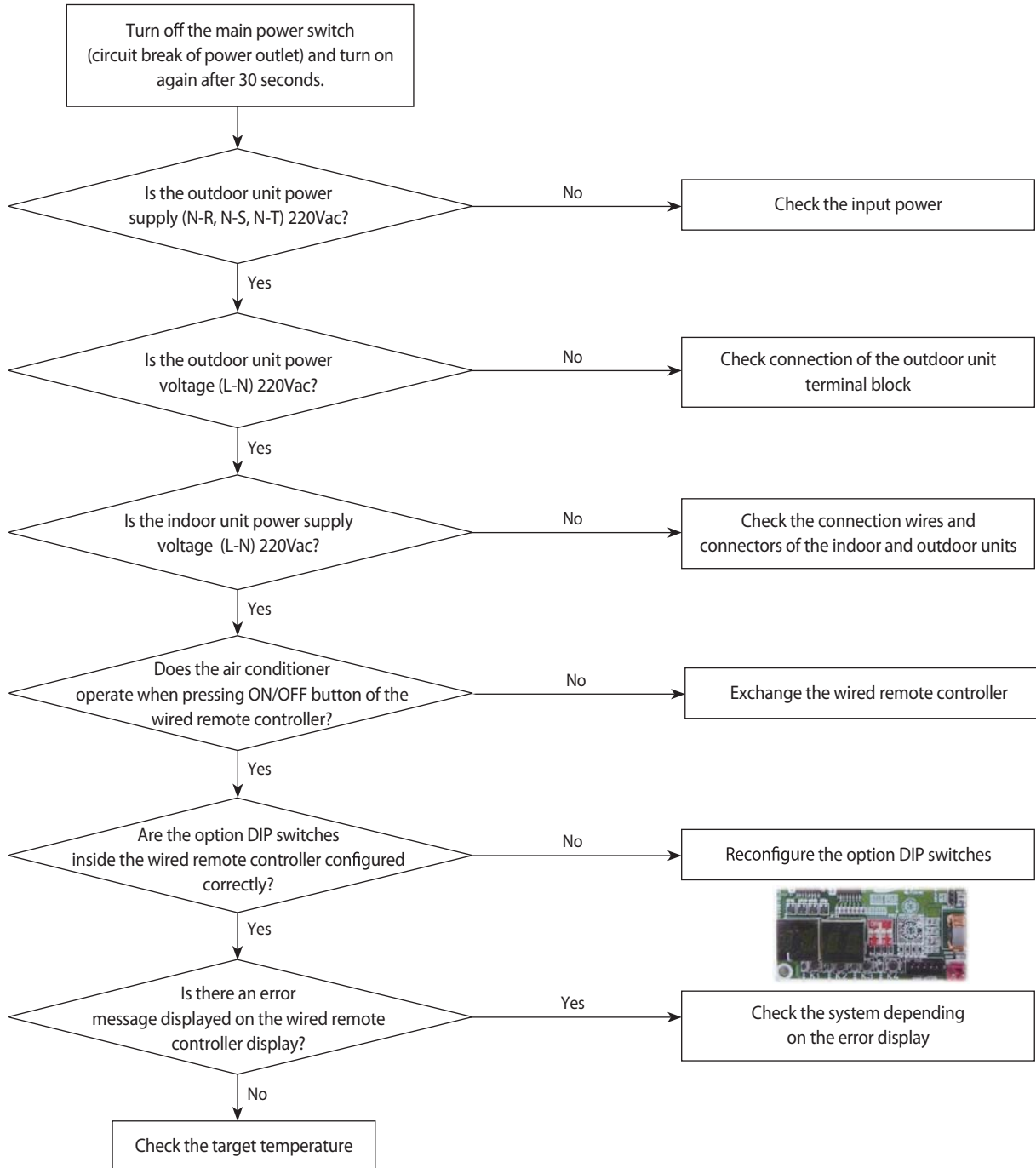

4-5-13 Outdoor unit power supply error

1. Checklist:
 - 1) Are the input power voltage and power connection correct?
 - 2) Is there any Fuse Short of the indoor or outdoor unit?
 - 3) Is any LED lit on both MAIN PCB and INVERTER PCB?
 - 4) Are Reactor wires of the outdoor unit connected correctly?

2. Troubleshooting procedure

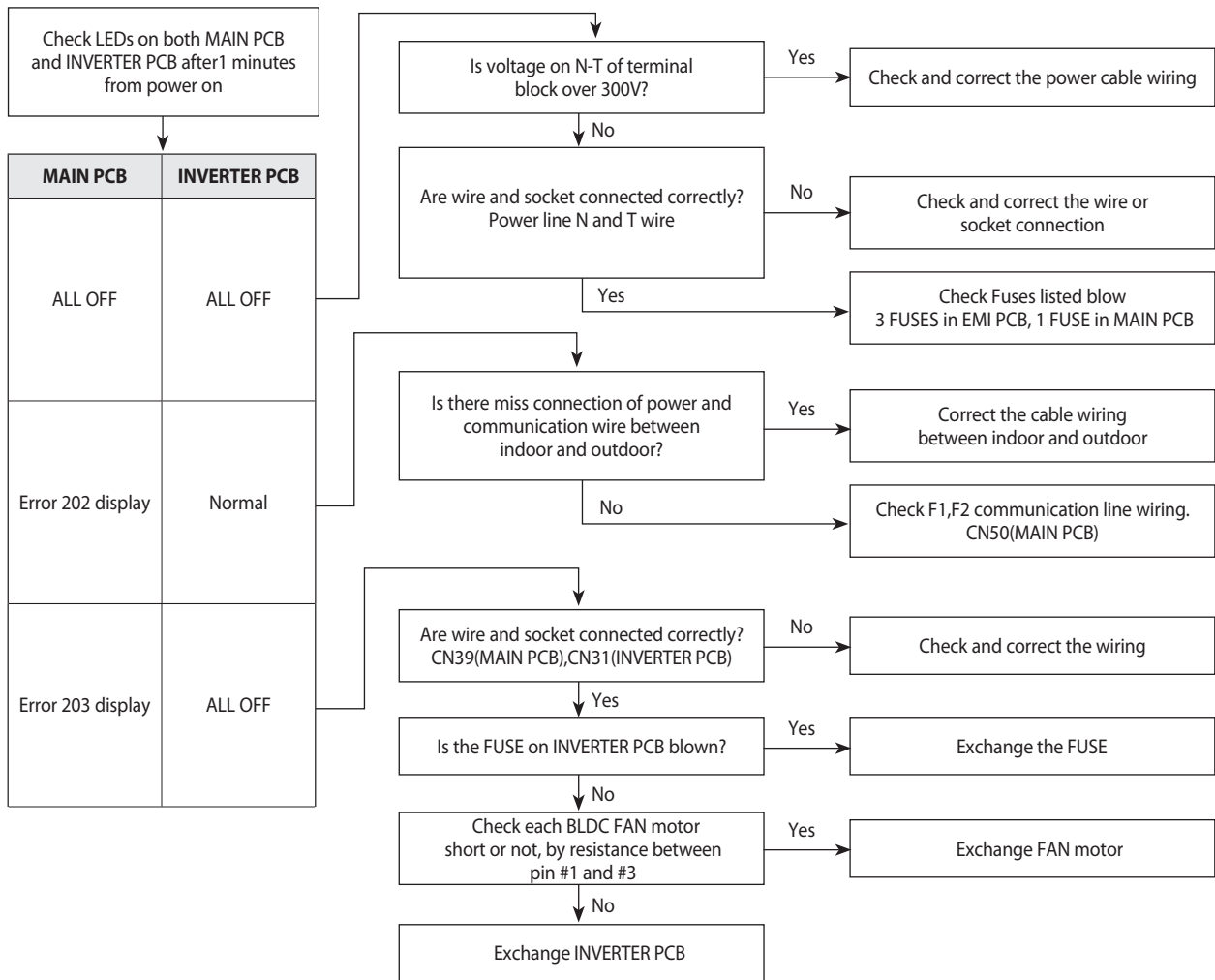

5. PCB Diagram

5-1 Hydro unit

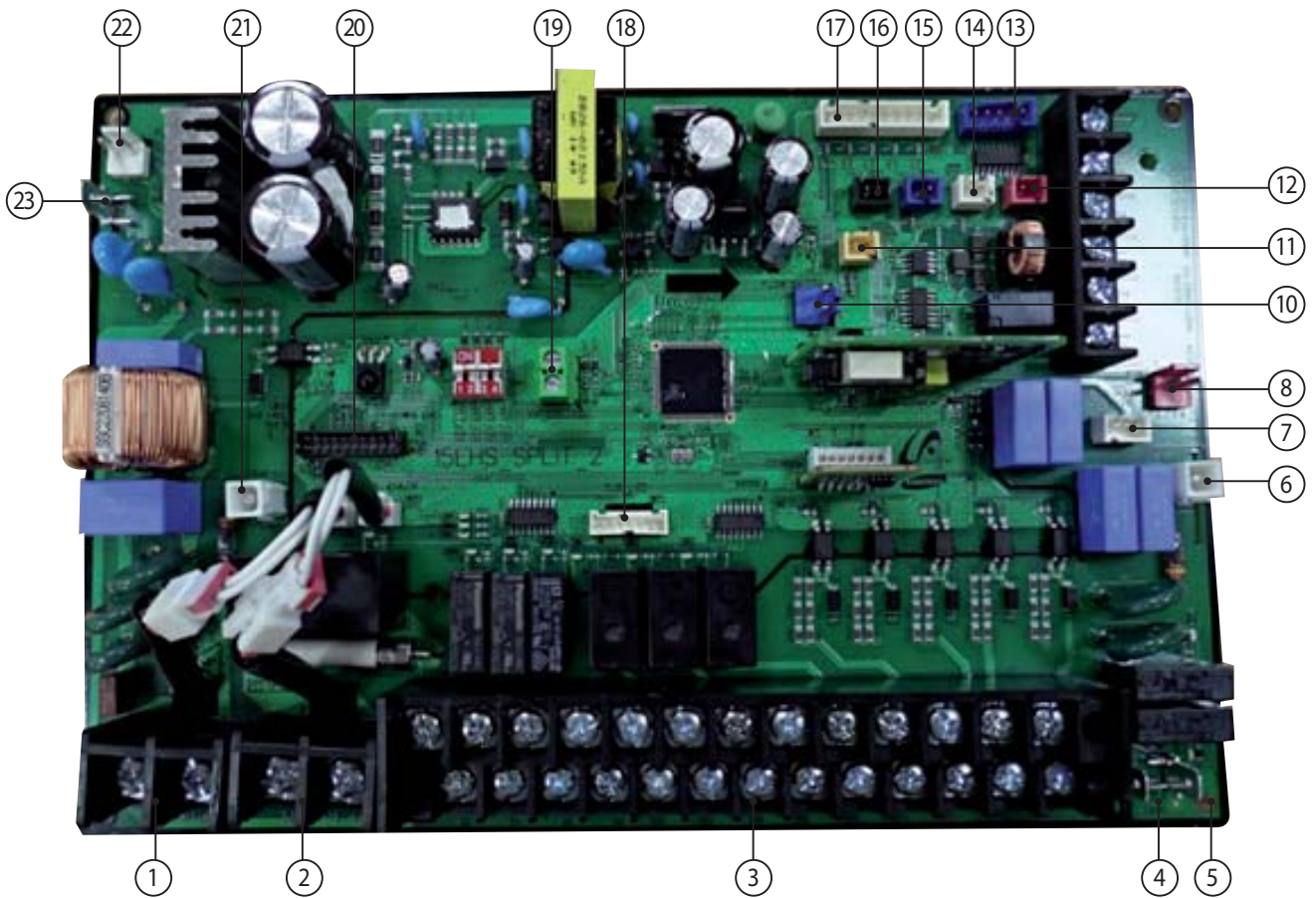

This Document can not be used without Samsung's authorization.

No.	Local	Function	Description
1	TB-A	MAIN POWER	DAPC 3013-2P BLK
2	TB-A1	BOOST HEATER	DAPC 3013-2P BLK
3	TB-B	EXTERNAL CONTROL	BR-1000C2-26P BLK
4	CNP001	MC2-A	YTR250
5	CNP002	MC1-A	YTR250
6	CN303	EARTH	YDW236-01 WHT
7	CNS1	WATER PUMP SIG/GND	SMW250-03 WHT
8	CNS304	WIRED REMOCON F3/F4	YW396-02V RED
9	TB-C	F1-F2/DC12V-GND/F3-F4	DAPC 2009-6P BLK
10	CNS041	FLOW SWITCH	YW396-02V BLU
11	CNS042	WATER TANK	SMW250-02 YEL
12	CNS046	SMART GRID	SMW250-02 RED
13	CNS062	EEV	SMW250-05 BLU
14	CNS044	ROOM	SMW250-02 WHT
15	CNS045	MIXING SENSOR	SMW250-02 BLU
16	CNS047	HEATER	SMW250-02 BLK
17	CNS043	HEATER/EVA-OUT/EVA-IN/WATER-OUT/WATER-IN	SMW250-10 WHT
18	CNS201	SUB_LED	SMW200-07 WHT
19	CNS2	FR_CONTROL	AKZ350 GRN
20	CNS301	DOWNLOAD	YDW200-20 BLK
21	CN101	EARTH	YDW236-01 WHT
22	CNP401	B/UP HEATER_N	YW396-02V WHT
23	CNP003	MC2-B	YTR250

5-2 Outdoor Unit

MAIN PCB

(AE090/120/140/160JXEDEH/EU, AE090/120/140/160JXEDGH/EU)

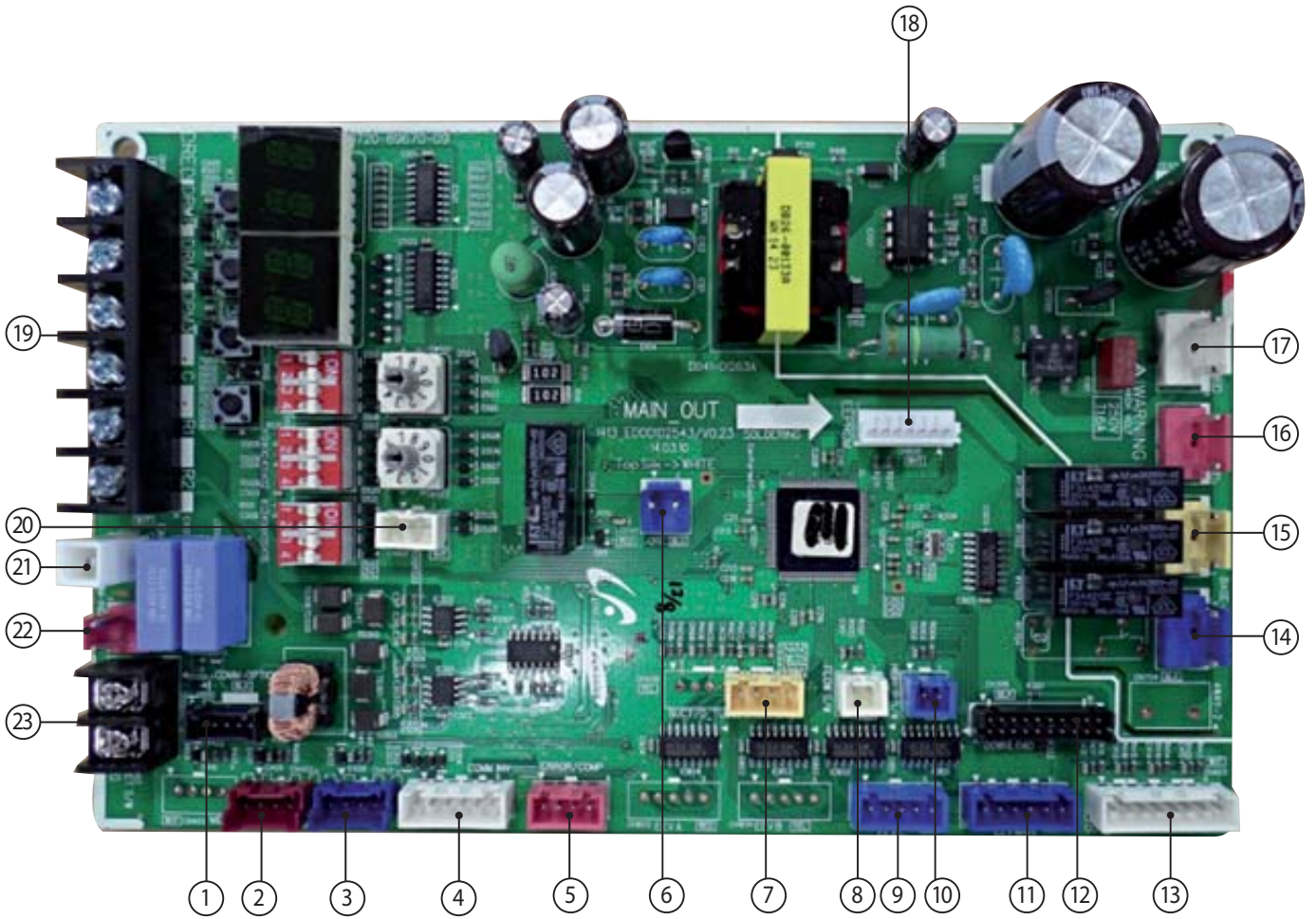

This Document can not be used without Samsung's authorization.

No.	Local	Function	Description
1	CN302	COMM-OPTION	SMW200-05 BLK
2	CN402	HIGH PRESSURE S/W	B04B-XARK-1 RED
3	CN401	LOW PRESSURE S/W	B04B-XARK-1 BLU
4	CN305	COMM INV	SMW250-06 WHT
5	CN801	ERROR/COMP CHECK	SMW250-04 RED
6	CN12	DC12V	YW396-02V BLU
7	CN407	WATER-IN/OUT	SMW250-04 YEL
8	CN001	EVA-IN	SMW250-02 WHT
9	CN803	EEV1	SMW250-05 BLU
10	CN407	HIGH_P S/W	SMW250-02 BLU
11	CN802	EEV4	SMW250-06 BLU
12	CN306	DOWNLOAD	YDW200-20P BLK
13	CN403	OUT TEMP/COND/DISQ/OLP	SMW250-08 WHT
14	CN703	BASE-HEATER	YW396-03AV BLU
15	CN702	4WAY-1	YW396-03AV YEL
16	CN701	HOTGAS	YW396-03AV RED
17	CN101	POWER	YW396-03AV WHT
18	CN806	EEPROM	B7P-MQ WHT
19	CN304	DRED	DAPC-2009-6P BLK
20	CN501	MODE SELECTOR	SMW250-03 WHT
21	CN103	EARTH	YDW236-01 WHT
22	CN303	COMM-INDOOR	YW396-02V RED
23	CN003	QUIET S/W	BR-7623-2P BLK

INVERTER PCB (AE090JXEDEH/EU)

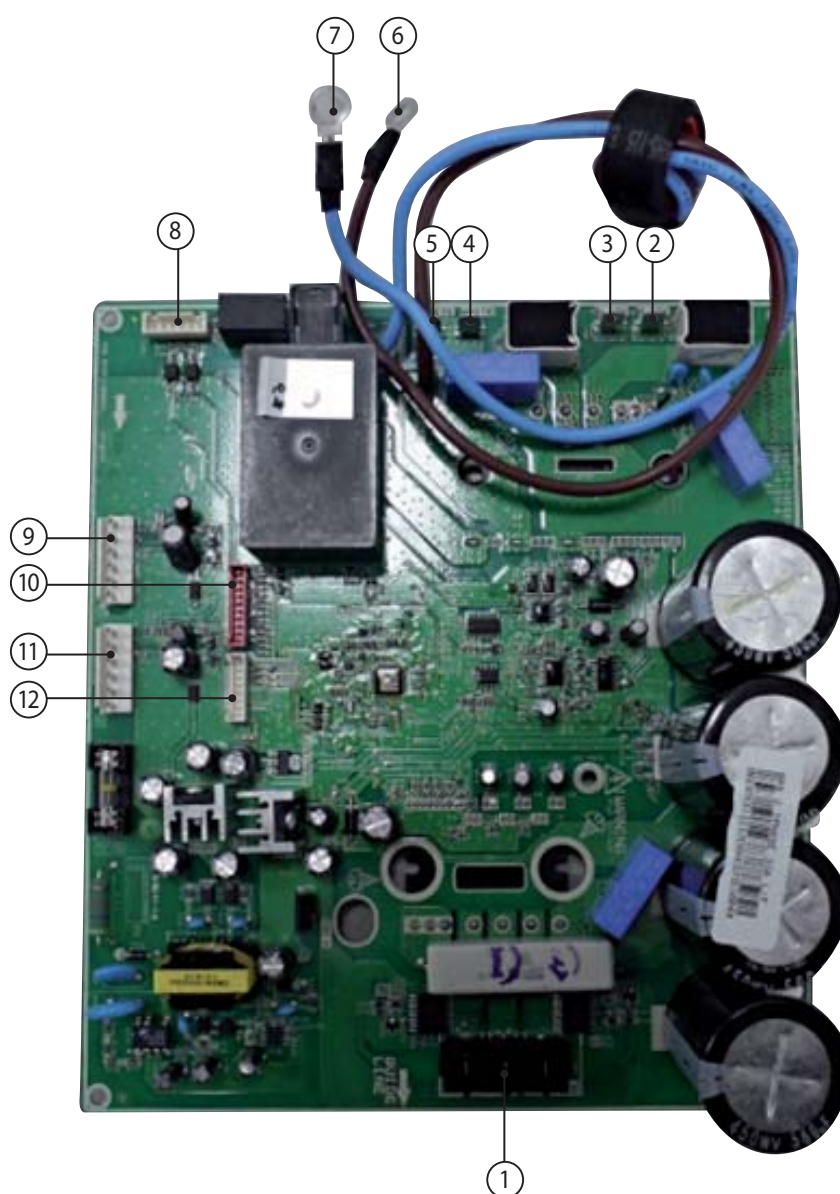

This Document can not be used without Samsung's authorization.

No.	Local	Function	Description
1	CN71	COMP	42819-3213 BLK
2	REACTOR-A2	REACTOR_A	YTR250
3	REACTOR-B2	REACTOR_B	YTR250
4	REACTOR-A1	REACTOR_A	YTR250
5	REACTOR-B1	REACTOR_B	YTR250
6	L	AC POWER	BRN WIRE
7	N	AC POWER	SKY/BLU WIRE
8	CN31	MAIN COMM	SMW250-06 WHT
9	CN91	BLDC FAN2	YW396-06V WHT
10	C22	DOWNLOADER	SMW200-10 RED
11	CN90	BLDC FAN1	YW396-06V WHT
12	CN21	DAC/ENCODER	SMW200-08 WHT

INVERTER PCB (AE120/140/160JXEDEH/EU)

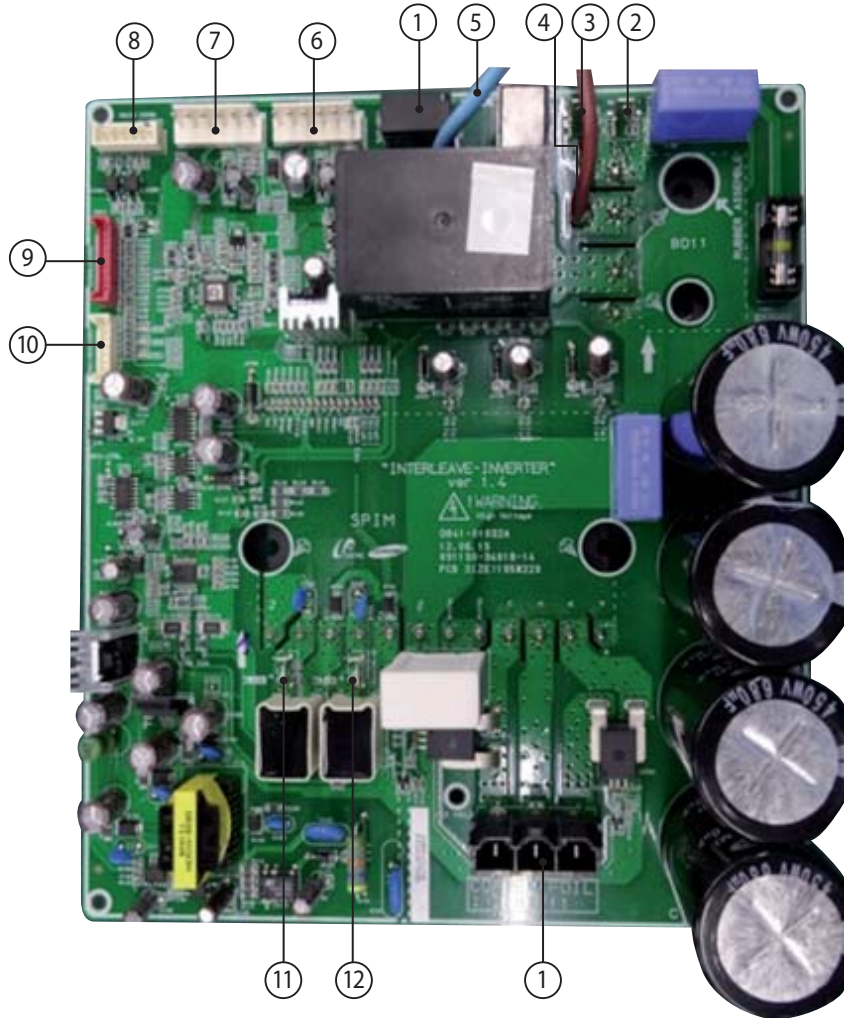

This Document can not be used without Samsung's authorization.

No.	Local	Function	Description
1	CN32	COMP	42819-3213 BLK
2	REACTOR-A1	REACTOR_A	YTR250
3	REACTOR-B1	REACTOR_B	YTR250
4	L	AC POWER	BRN WIRE
5	N	AC POWER	SKY/BLU WIRE
6	CN91	BLDC FAN2	YW396-06V WHT
7	CN90	BLDC FAN1	YW396-06V WHT
8	CN31	MAIN COMM	SMW250-06 WHT
9	C22	DOWNLOADER	SMW200-10 RED
10	CN21	DAC/ENCODER	SMW200-08 WHT
11	REACTOR-B2	REACTOR_B	YTR250
12	REACTOR-A2	REACTOR_A	YTR250

INVERTER PCB (AE090/120/140/160JXEDGH/EU)

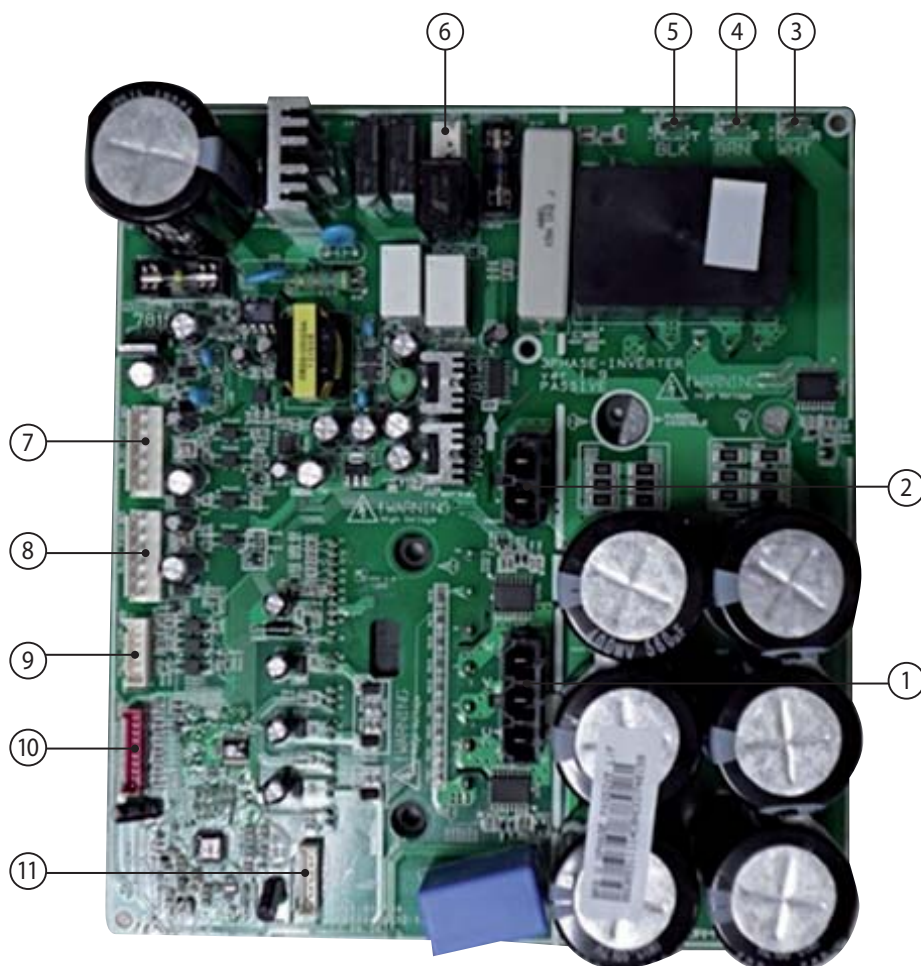

This Document can not be used without Samsung's authorization.

No.	Local	Function	Description
1	CN800	COMP	42819-3213 BLK
2	CN600	REACTOR	HLW1005-02 BLK
3	R	R-IN	YTR250
4	S	S-IN	YTR250
5	T	T-IN	YTR250
6	CN100	POWER	YW396-03AV WHT
7	CN91	BLDC FAN2	YW396-06V WHT
8	CN90	BLDC FAN1	YW396-06V WHT
9	CN31	MAIN COMM	SMW250-06 WHT
10	CN22	DOWNLOADER	SMW200-10 RED
11	CN21	DAC/ENCODER	SMW200-08 WHT

EMI PCB
(AE120/140/160JXEDEH/EU)

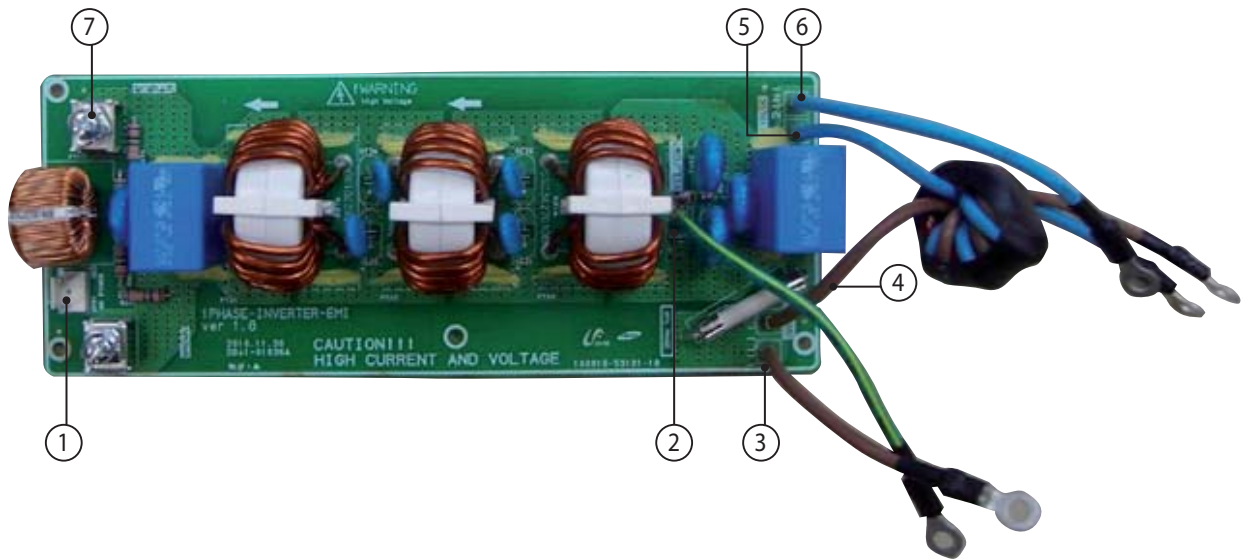

This Document can not be used without Samsung's authorization.

No.	Local	Function	Description
1	L1	POWER	OT-048
2	EARTH	EARTH	YEL/GRN WIRE
3	1(L)	POWER	BRN WIRE
4	L	POWER	BRN WIRE
5	N	POWER	SKY/BLU WIRE
6	2(N)	POWER	SKY/BLU WIRE
7	N1	POWER	OT-048
8	CN01	AC POWER	YW396-03AV WHT

EMI PCB (AE120/140/160JXEDGH/EU)

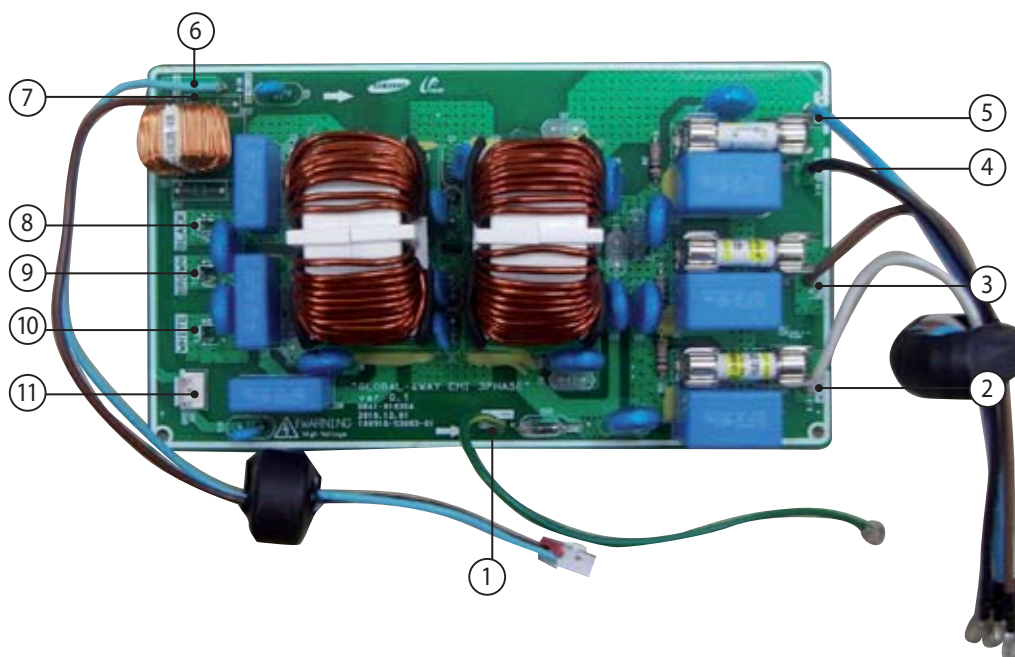

This Document can not be used without Samsung's authorization.

No.	Local	Function	Description
1	EARTH	EARTH	YEL/GRN WIRE
2	R-IN	POWER	WHT WIRE
3	S-IN	POWER	BRN WIRE
4	T-IN	POWER	BLK WIRE
5	N-IN	POWER	SKY/BLU WIRE
6	N-INV	POWER	SKY/BLU WIRE
7	T-INV	POWER	BRN WIRE
8	T-OUT	POWER	BLK WIRE
9	S-OUT	POWER	BRN WIRE
10	R-OUT	POWER	WHT WIRE
11	CN01	POWER	YW396-03AV WHT

SUB-HEATER PCB
 (AE090/120/140/160JXEDEH/EU, AE090/120/140/160JXEDGH/EU)

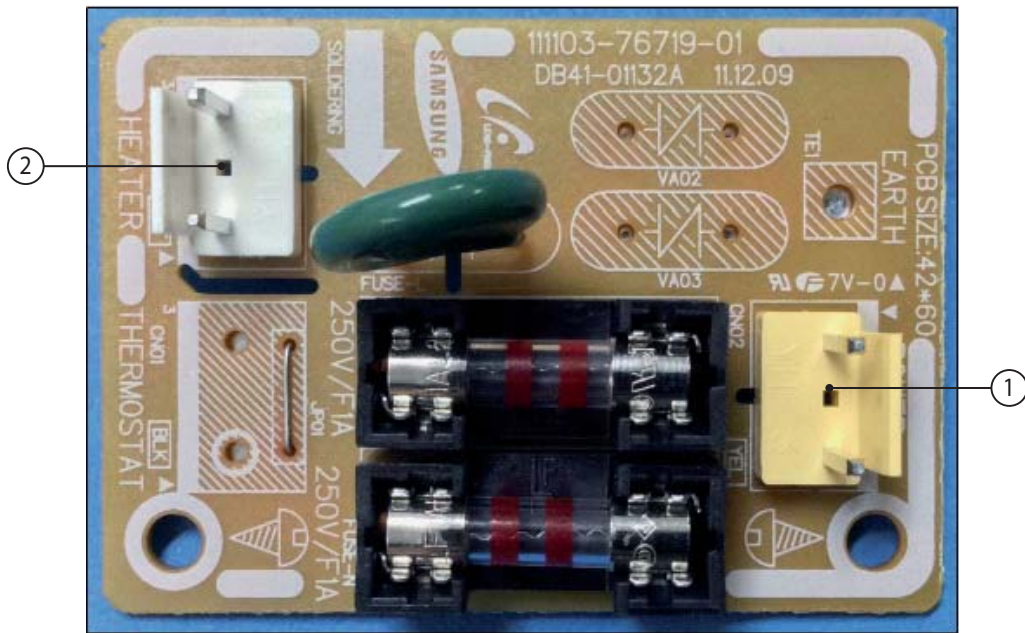

This Document can not be used without Samsung's authorization.

No.	Local	Function	Description
1	CN02	POWER	YW396-03AV YEL
2	CN03	HEATER	YW396-03AV WHT

INVERTER PCB
(AE040/060JXEDEH/EU)

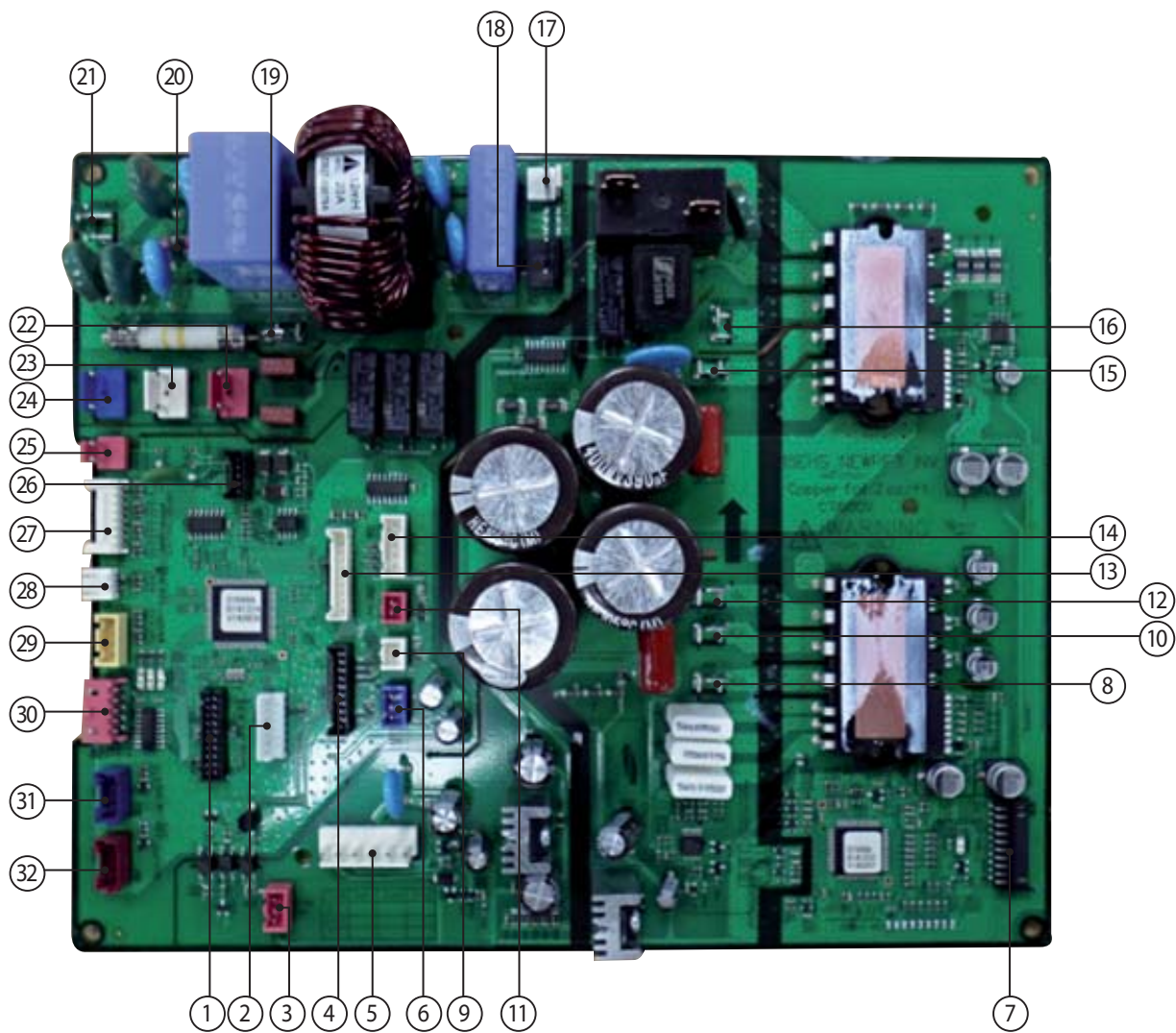

This Document can not be used without Samsung's authorization.

No.	Local	Function	Description
1	CN201	DOWNLOAD-MAIN	YDW200-20 BLK
2	CN202	EEPROM	B7P-MQ WHT
3	CN153	SMPS DC15V	SMW250-03 RED
4	CN207	SUB PBA	SMW200-10 BLK
5	CN901	BLDC MOTOR	YW396-06V WHT
6	CN152	SMPS DC12V	SMW250-03 BLU
7	CN551	DOWNLOAD-MAIN	YDAW200-20 BLK
8	CN401	COMP_U	YTR250
9	CN203	TB-FUSE	SMW250-02 WHT
10	CN402	COMP_V	YTR250
11	CN246	QUIET_SW	SMW250-02 RED
12	CN403	COMP_W	YTR250
13	CN206	SUB PBA	SMW200-10 WHT
14	CN204	DRED	SMW250-05 WHT
15	CN051	REACTOR	YTR250
16	CN052	REACTOR	YTR250
17	CN150	SMPS POWER	YW396-03 BLK
18	CN151	HIGH-PRESS S/W	YW396-02V WHT
19	CN002	POWER	YTR250
20	CN003	EARTH	GP881205
21	CN001	POWER	YTR250
22	CN241	HOT GAS	YW396-03AV RED
23	CN030	4WAY	YW396-03AV WHT
24	CN242	BASE-HEATER	YW396-03AV BLU
25	CN301	COMM	YW396-02V RED
26	CN205	SUB PBA	SMW200-05 BLK
27	CN251	SENSOR OLP/COND/DIS/OUT	SMAW200-08 WHT
28	CN245	EVA_IN	SMAW250-02 WHT
29	CN252	WATER	SMW250-04 YEL
30	CN701	EEV	SMAW250A-05 RED
31	CN801	LOW-PRESS SENSOR	B04B-XAEK-1
32	CN809	HIGH-PRESS SENSOR	B04B-XARK-1

SUB-DISPLAY PCB (AE040/060JXEDEH/EU)



This Document can not be used without Samsung's authorization.

No.	Local	Function	Description
1	CN518	DC POWER	SMW200-05 BLK
2	CN502	MAIN-SUB SIGNAL	SMW200-10 BLK
3	CN511	DC 12V	YW396-02V BLU
4	CN01	SOLUTION_COMM	AKZ350 GRN
5	CN501	MAIN-SUB SIGNAL	SMW200-10 BLU

6. Wiring Diagram

6-1 Hydro unit

6-1-1 3Phase Model

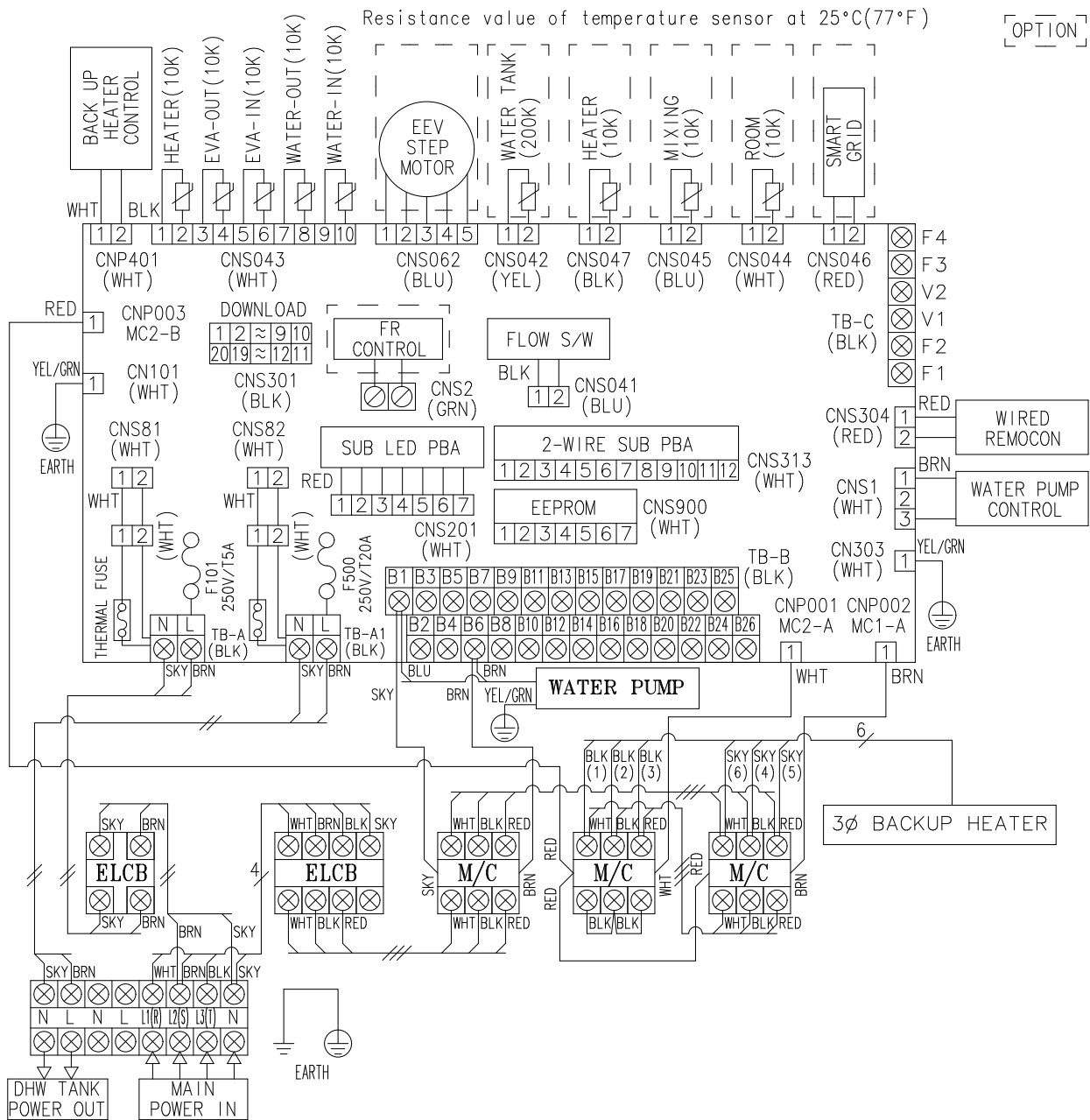

This Document can not be used without Samsung's authorization.

6-1-2 1Phase Model

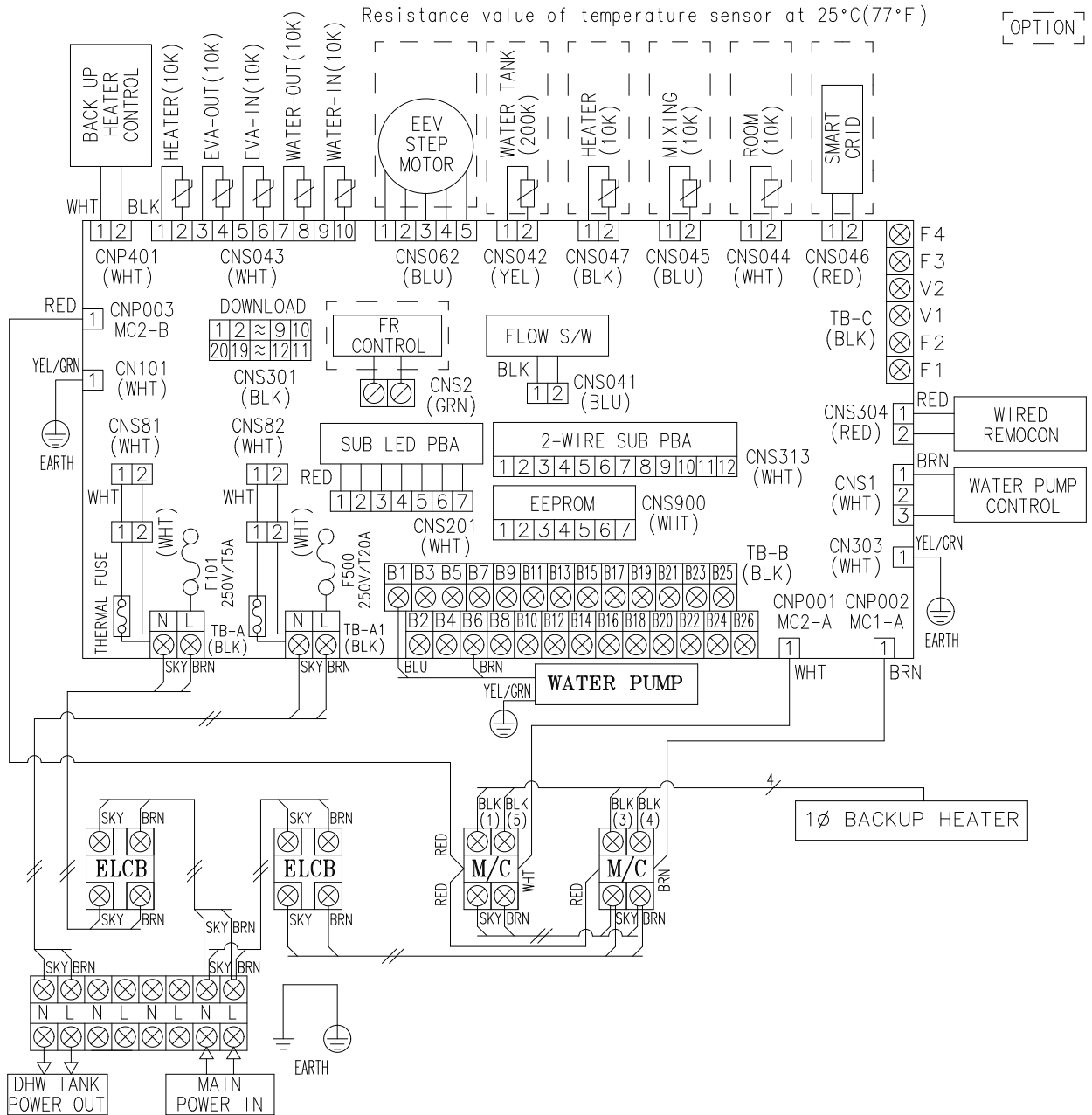

This Document can not be used without Samsung's authorization.

6-2 Outdoor Unit

3Phase (AE090/100/120/140JXEDGH)

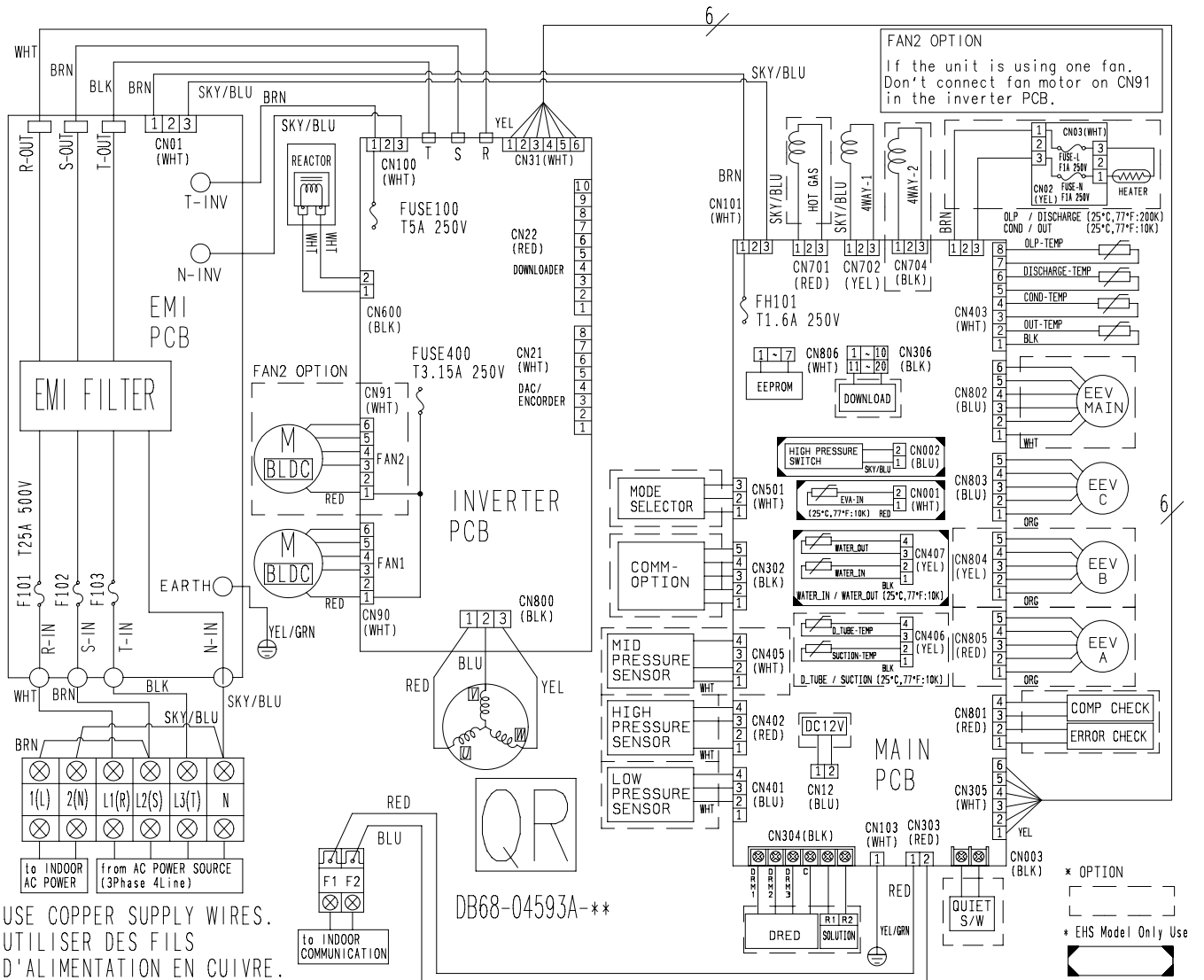

This Document can not be used without Samsung's authorization.

1Phase (AE090/100/120/140JXEDEH)

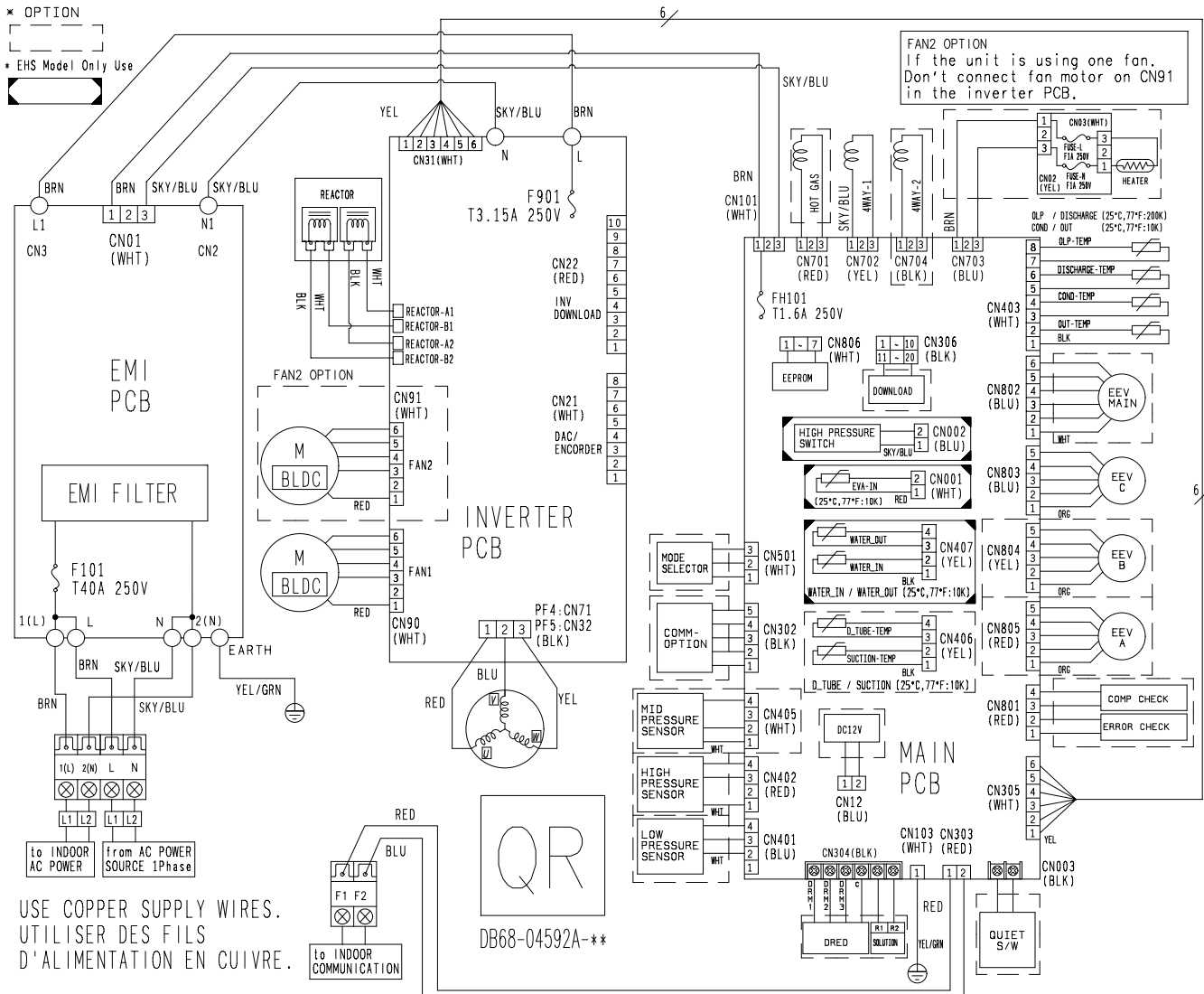

This Document can not be used without Samsung's authorization.

1Phase (AE040/060JXEDEH)

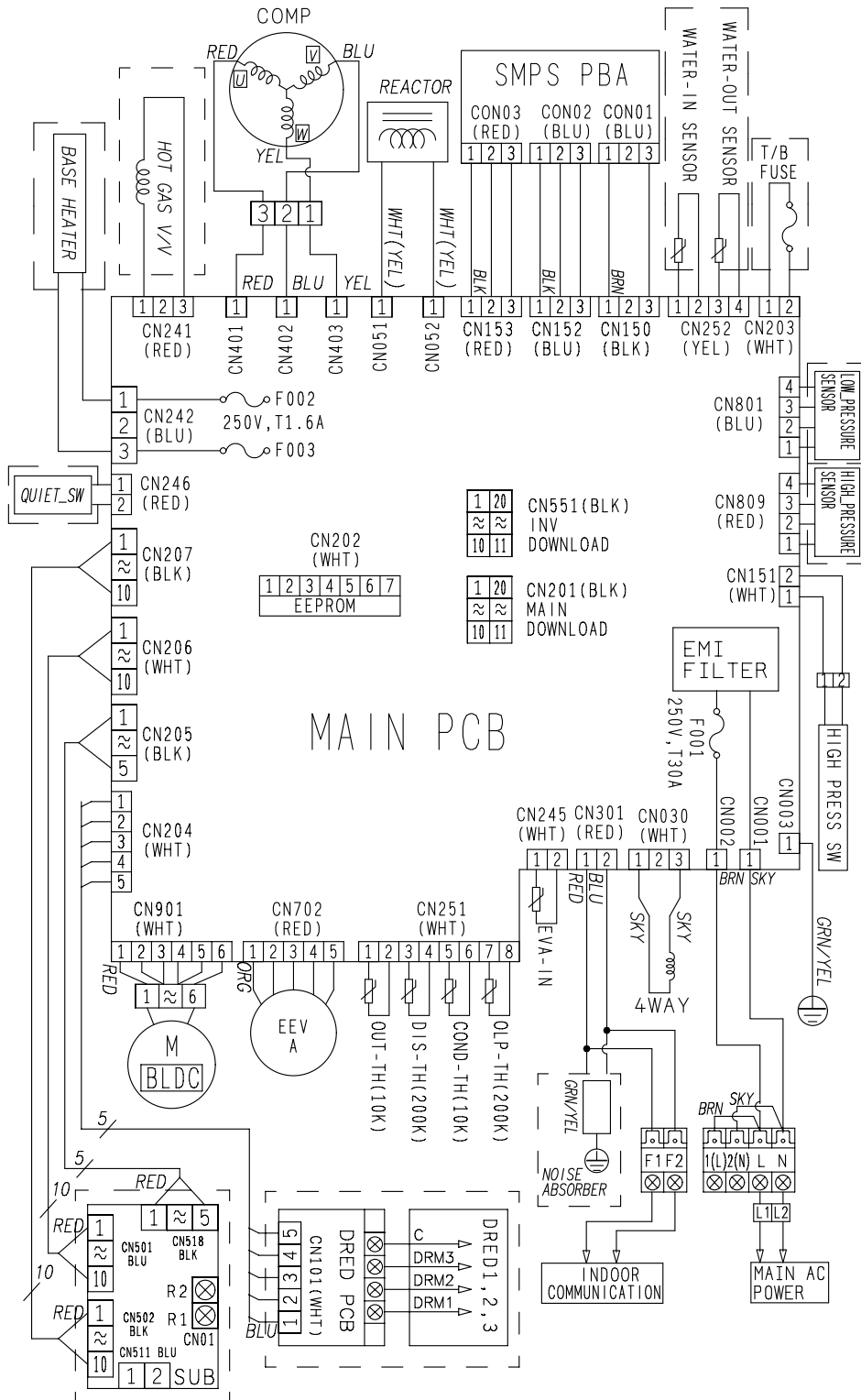

※ NOTE [=] Option
 THERMISTOR MARK BASED ON THE TEMP at 25°C, 77°F

This Document can not be used without Samsung's authorization.

7. Reference Sheet

7-1 Index for Model Name

7-1-1 Outdoor Unit

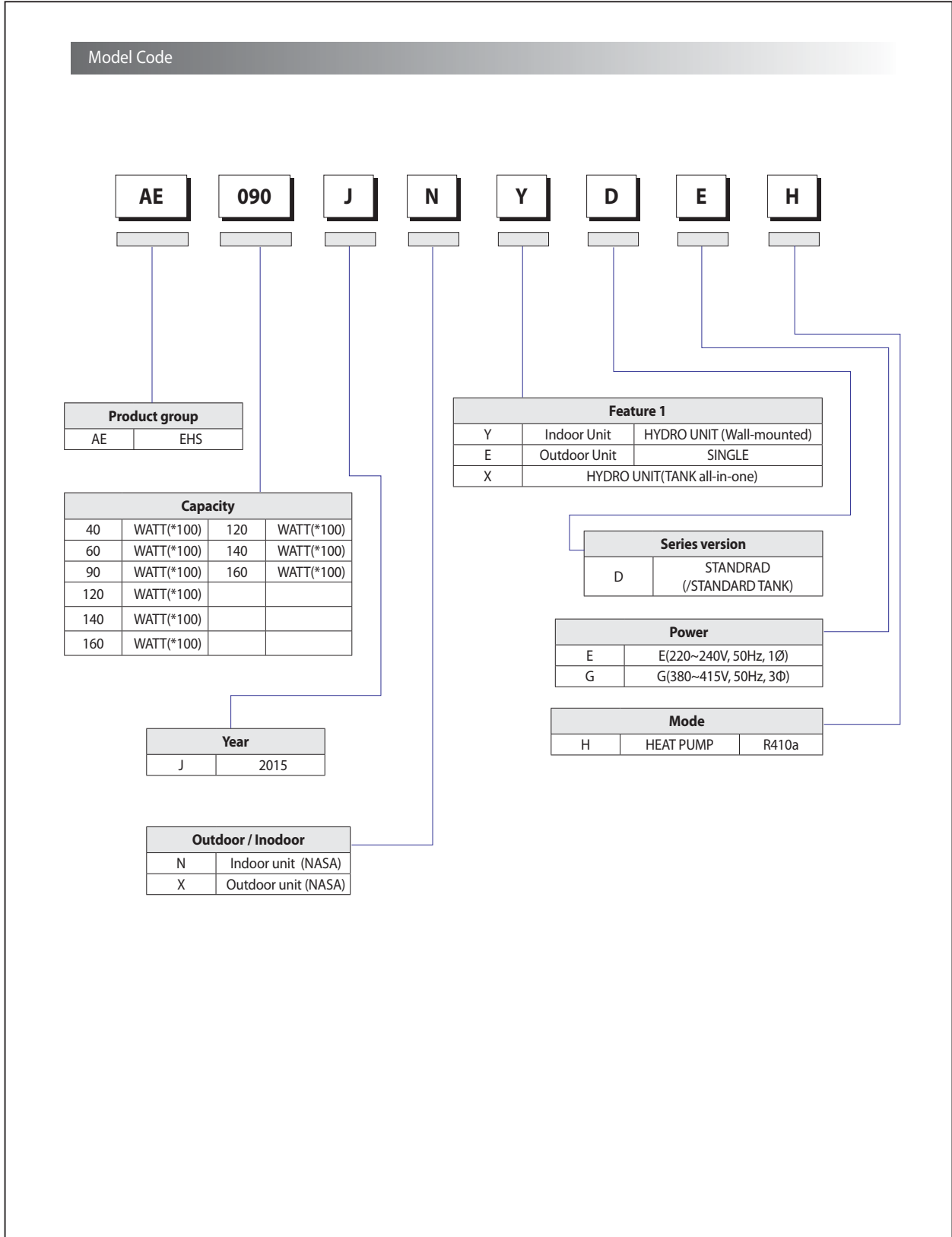

7-2 Refrigerant Circuit Diagram

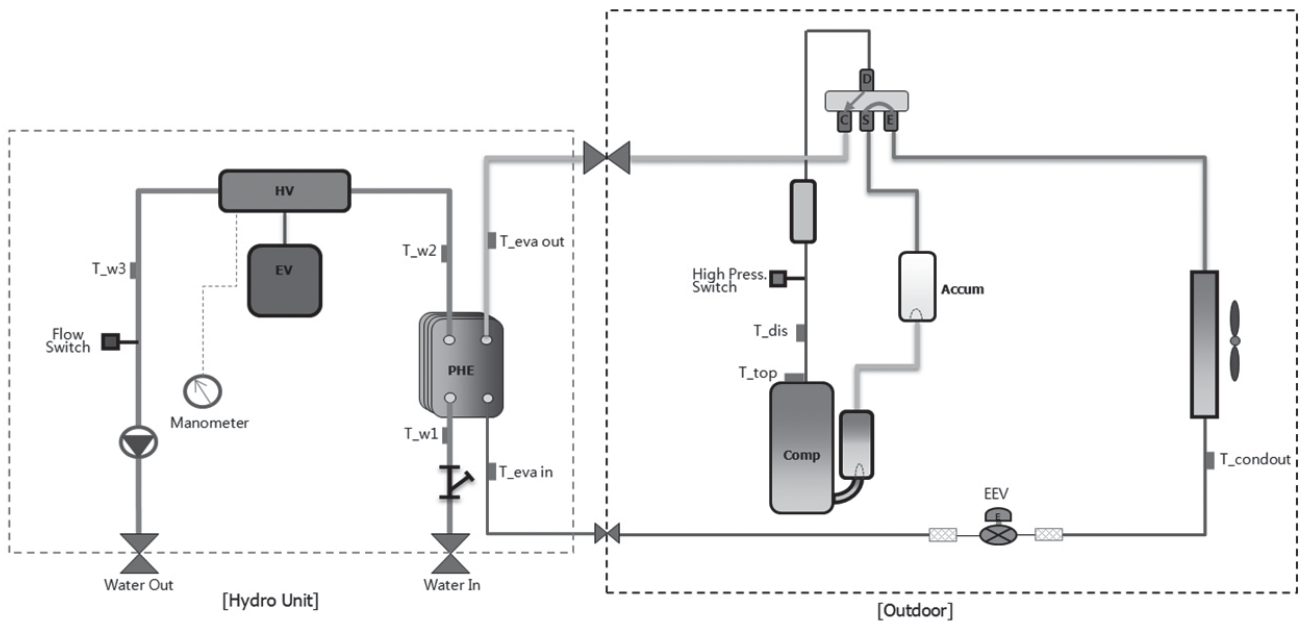

This Document can not be used without Samsung's authorization.

Part	Description
T_w1	Water Inlet temp sensor
T_w2	Water PHX Outlet temp sensor
T_w3	Water Outlet temp sensor
T_top	Compressor Top temp sensor
T_dis	Discharge temp sensor
T_eva in	Eva In temp sensor
T_eva out	Eva Out temp sensor
T_condout	Condout temp sensor
PHE	Plate heat exchanger
HV	Heater vessel
EV	Expansion vessel

* The Direction of this product 4WAY V/V connection is heating default.
(Heating : 4Way valve Off, Cooling : 4Way valve ON)

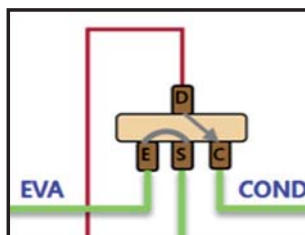

Normal A/C

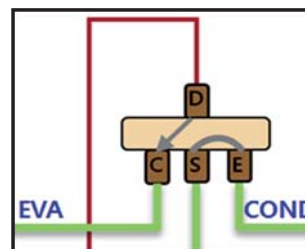

EHS SPLIT
(AE***JXED*H)

7-2 FSV data check and update using S-Net Pro2

To check the EHS HE / HT FSV data the [Update] button must be selected.

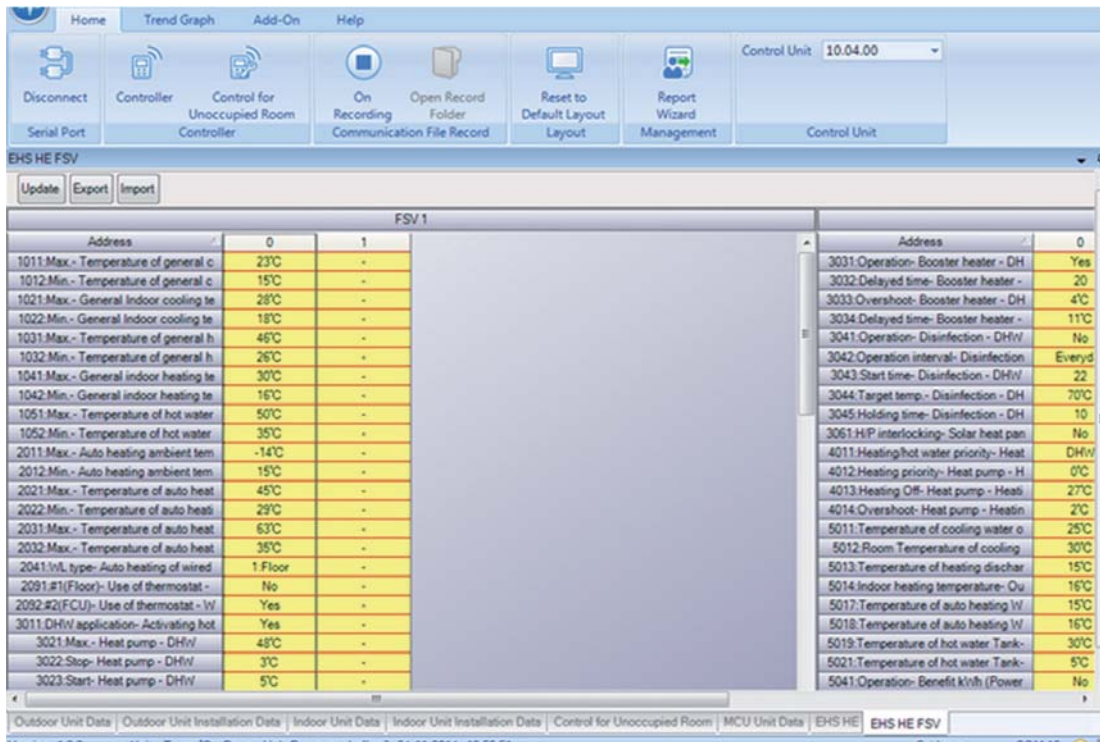

FSV value has been updated, double-click each cell can set the value of the FSV.

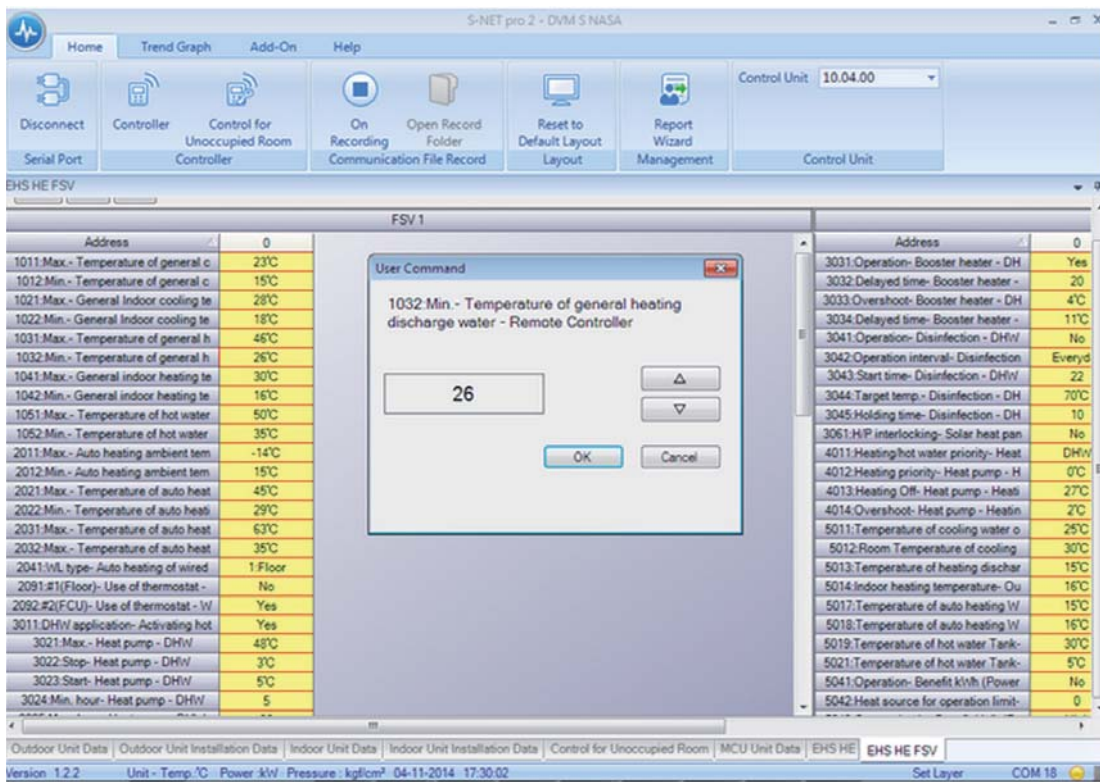

7-3 EHS FSV Values Import and Export

The User can now export the existing FSV values into an XML file and update later onto a new unit the saved values.

The screenshot displays the EHS HE FSV software interface. At the top, there is a menu bar with 'Home', 'Trend Graph', 'Add-On', and 'Help'. Below the menu bar are several icons for 'Disconnect', 'Controller', 'Control for Unoccupied Room Controller', 'On Recording', 'Open Record Folder', 'Reset to Default Layout', and 'Report Wizard Management'. A 'Control Unit' dropdown menu is set to '10.04.00'. Below the icons are buttons for 'Update', 'Export', and 'Import'. The main area shows two tables of FSV values. The left table is titled 'FSV 1' and the right table is titled 'FSV 2'. Both tables have columns for 'Address', '0', and '1'. The 'Address' column contains various sensor and control parameters, and the '0' and '1' columns contain numerical values or status indicators.

Address	0	1
1011.Max- Temperature of general c	23°C	-
1012.Min- Temperature of general c	15°C	-
1021.Max- General Indoor cooling te	28°C	-
1022.Min- General Indoor cooling te	18°C	-
1031.Max- Temperature of general h	45°C	-
1032.Min- Temperature of general h	26°C	-
1041.Max- General indoor heating te	30°C	-
1042.Min- General indoor heating te	16°C	-
1051.Max- Temperature of hot water	50°C	-
1052.Min- Temperature of hot water	35°C	-
2011.Max- Auto heating ambient tem	-14°C	-
2012.Min- Auto heating ambient tem	15°C	-
2021.Max- Temperature of auto heat	45°C	-
2022.Min- Temperature of auto heat	29°C	-
2031.Max- Temperature of auto heat	63°C	-
2032.Max- Temperature of auto heat	35°C	-
2041:1/L type- Auto heating of wired	1 Floor	-
2091:#1(Floor)- Use of thermostat -	No	-
2092:#2(FCU)- Use of thermostat - W	Yes	-
3011.DH/W application- Activating hot	Yes	-
3021.Max- Heat pump - DH/W	45°C	-
3022.Stop- Heat pump - DH/W	3°C	-
3023.Start- Heat pump - DH/W	5°C	-

Address	0
3031.Operation- Booster heater - DH	Yes
3032.Delayed time- Booster heater -	20
3033.Overshoot- Booster heater - DH	4°C
3034.Delayed time- Booster heater -	11°C
3041.Operation- Disinfection - DH/W	No
3042.Operation interval- Disinfection	Everyd
3043.Start time- Disinfection - DH/W	22
3044.Target temp- Disinfection - DH	70°C
3045.Holding time- Disinfection - DH	10
3061.H/P interlocking- Solar heat pan	No
4011.Heating/hot water priority- Heat	DH/W
4012.Heating priority- Heat pump - H	0°C
4013.Heating Off- Heat pump - Heat	27°C
4014.Overshoot- Heat pump - Heat	2°C
5011.Temperature of cooling water o	25°C
5012.Room Temperature of cooling	30°C
5013.Temperature of heating dischar	15°C
5014.Indoor heating temperature- Ou	16°C
5017.Temperature of auto heating /W	15°C
5018.Temperature of auto heating /V	16°C
5019.Temperature of hot water Tank-	30°C
5021.Temperature of hot water Tank-	5°C
5041.Operation- Benefit Kish (Power	No

Export Values:

The existing FSV values can be exported by click on the "Export" button.

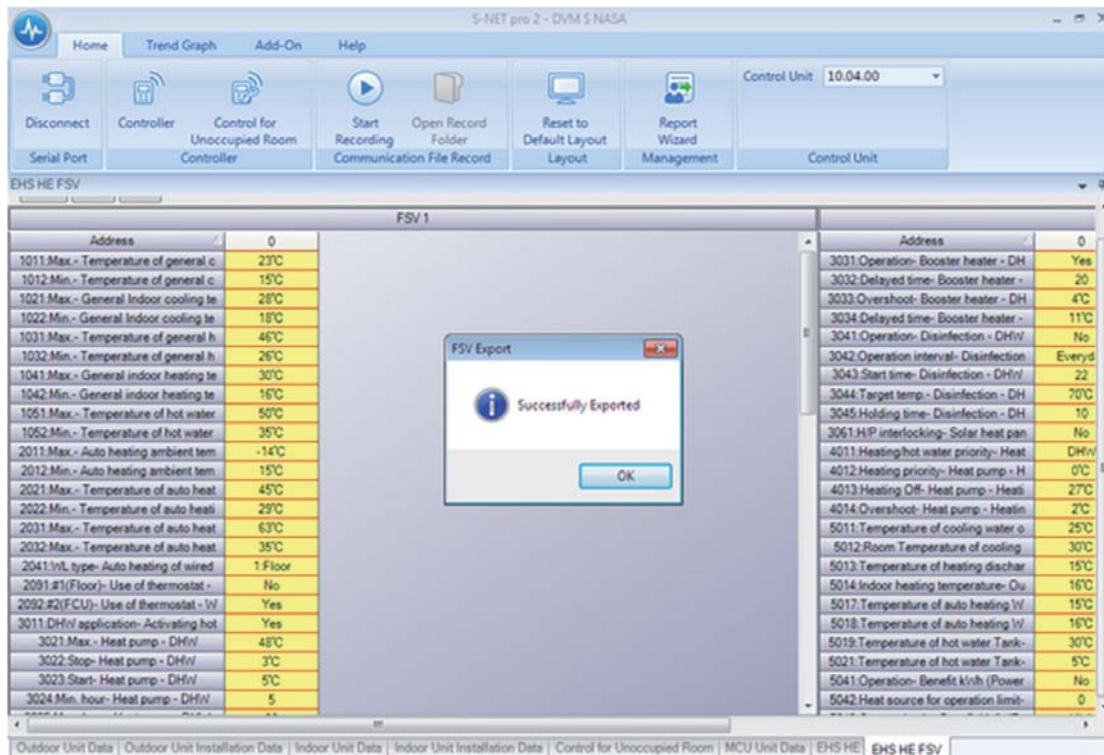
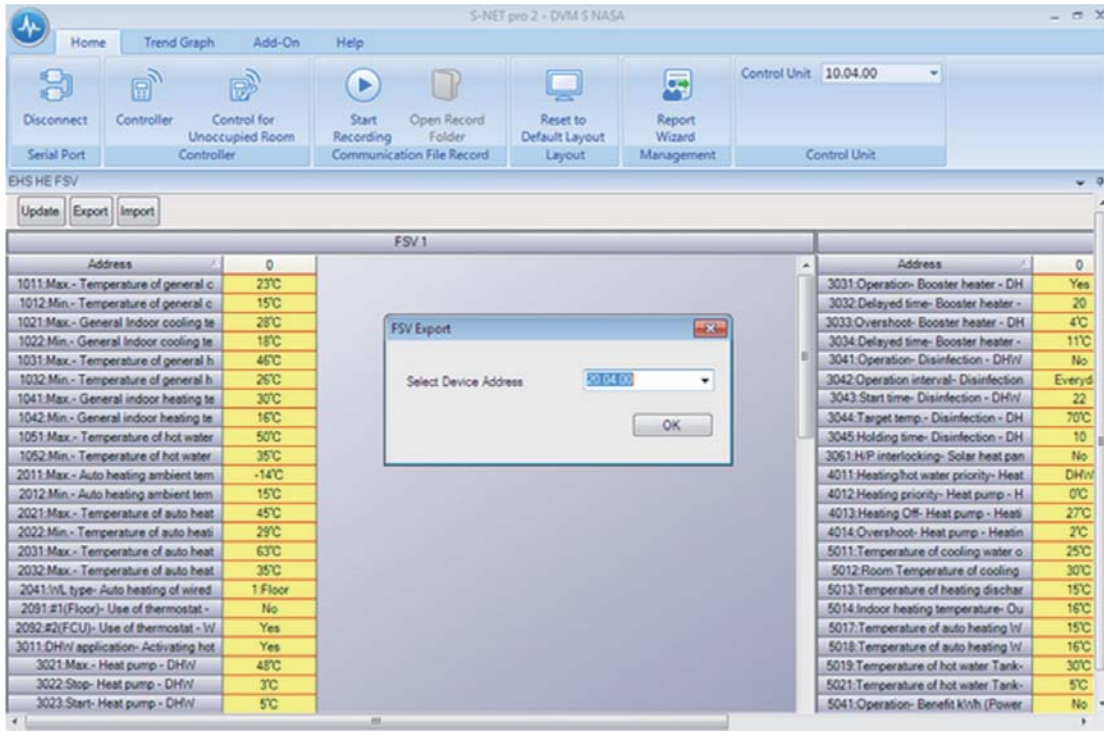

FSV Import:

The FSV values can be imported by the click on the import button.

The user is prompted to browse and select the XML file for update on the EHS unit selected in the dropdown menu.

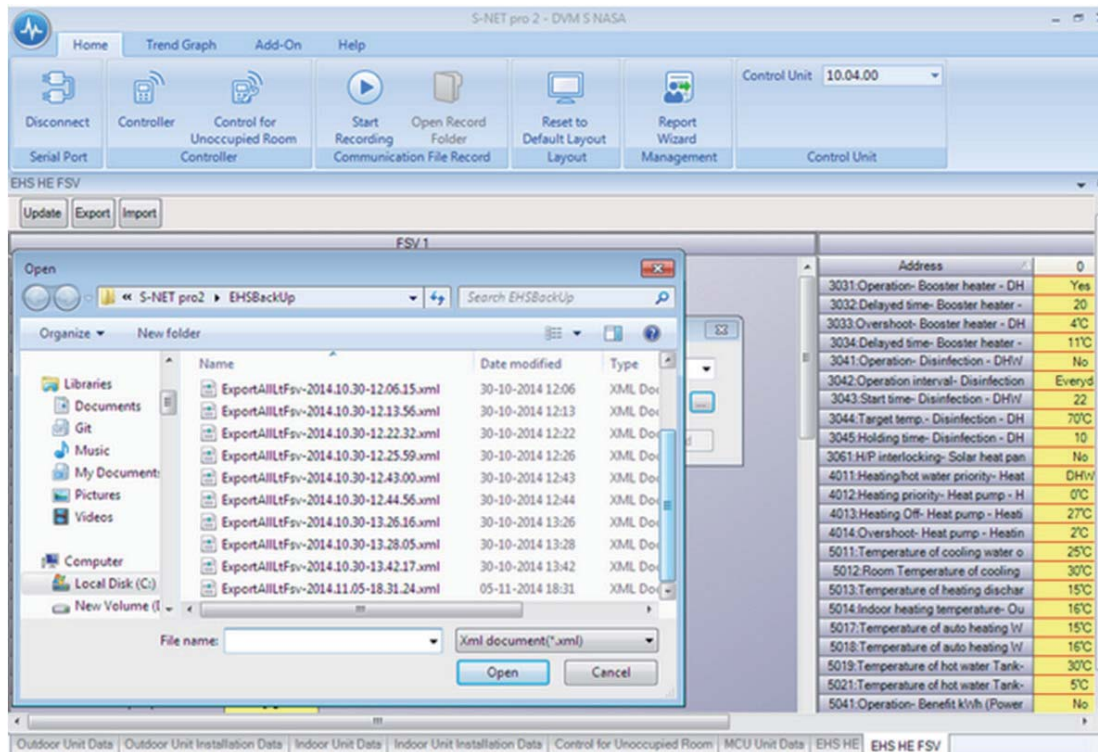
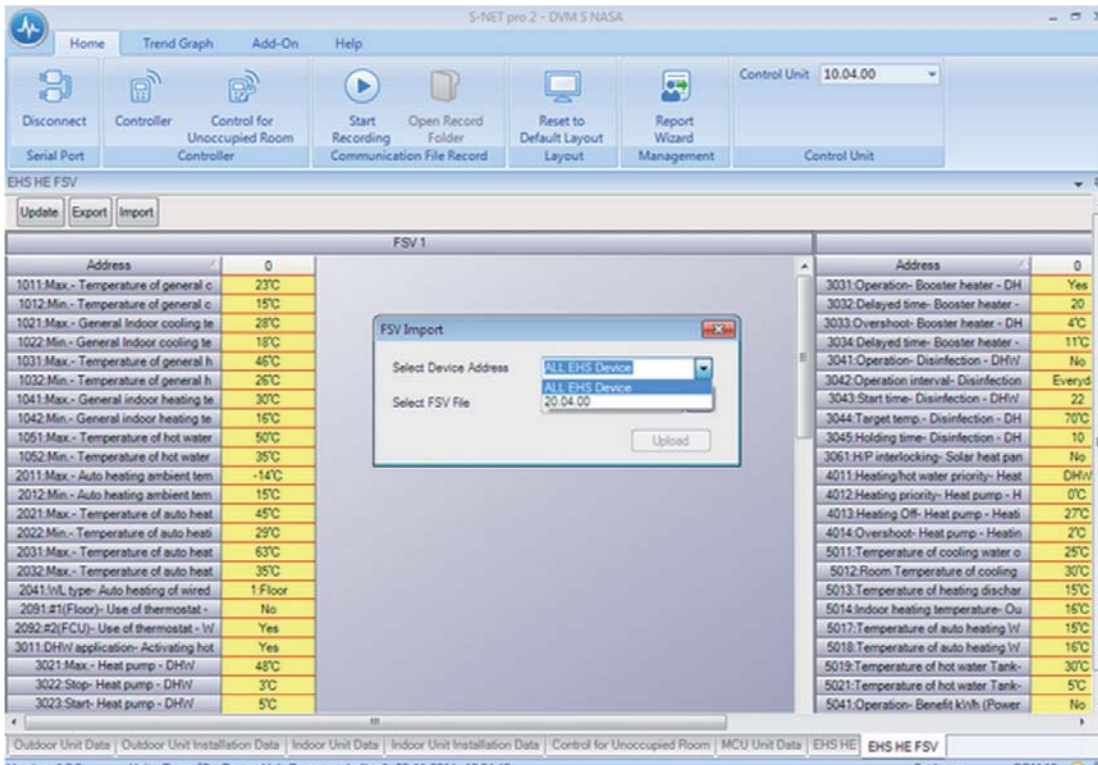

S-NET pro 2 - DVM 5 NASA

Home Trend Graph Add-On Help

Control Unit: 10.04.00

Disconnect Controller Control for Unoccupied Room Controller Start Recording Open Record Folder Reset to Default Layout Report Wizard Management Control Unit

EHS HE FSV

FSV 1

Address	Value	Address	Value
1011.Max - Temperature of general c	23°C	3031.Operation- Booster heater - DH	Yes
1012.Min - Temperature of general c	15°C	3032.Delayed time- Booster heater -	20
1021.Max - General Indoor cooling te	28°C	3033.Overshoot- Booster heater - DH	4°C
1022.Min - General Indoor cooling te	18°C	3034.Delayed time- Booster heater -	11°C
1031.Max - Temperature of general h	45°C	3041.Operation- Disinfection - DH/W	No
1032.Min - Temperature of general h	26°C	3042.Operation interval- Disinfection	Everyd
1041.Max - General indoor heating te	30°C	3043.Start time- Disinfection - DH/W	22
1042.Min - General indoor heating te	16°C	3044.Target temp - Disinfection - DH	70°C
1051.Max - Temperature of hot water	50°C	3045.Holding time- Disinfection - DH	10
1052.Min - Temperature of hot water	35°C	3061.H/P interlocking- Solar heat pan	No
2011.Max - Auto heating ambient tem	-14°C	4011.Heating/hot water priority- Heat	DH/W
2012.Min - Auto heating ambient tem	15°C	4012.Heating priority- Heat pump - H	0°C
2021.Max - Temperature of auto heat	45°C	4013.Heating Off- Heat pump - Heati	27°C
2022.Min - Temperature of auto heat	29°C	4014.Overshoot- Heat pump - Heatin	2°C
2031.Max - Temperature of auto heat	63°C	5011.Temperature of cooling water o	25°C
2032.Max - Temperature of auto heat	35°C	5012.Room Temperature of cooling	30°C
2041.WL type- Auto heating of wired	1 Floor	5013.Temperature of heating dischar	15°C
2091.#1(Floor)- Use of thermostat -	No	5014.Indoor heating temperature- Du	16°C
2092.#2(FCU)- Use of thermostat - W	Yes	5017.Temperature of auto heating W	15°C
3011.DH/W application- Activating hot	Yes	5018.Temperature of auto heating W	16°C
3021.Max - Heat pump - DH/W	48°C	5019.Temperature of hot water Tank-	30°C
3022.Stop- Heat pump - DH/W	3°C	5021.Temperature of hot water Tank-	5°C
3023.Start- Heat pump - DH/W	5°C	5041.Operation- Benefit k/h (Power	No
3024.Min. hour- Heat pump - DH/W	5	5042.Heat source for operation limit-	0

FSV Import

Successfully Imported

OK

Outdoor Unit Data | Outdoor Unit Installation Data | Indoor Unit Data | Indoor Unit Installation Data | Control for Unoccupied Room | MCU Unit Data | EHS HE | EHS HE FSV

Version 1.2.2 Unit - Temp:°C Power -kW Pressure -kgf/cm² 05-11-2014 18:36:40 Set Layer COM 18



GSPN(Global Service Partner Network)

Area	Web Site
Europe, CIS, Mideast & Africa	gspn1.samsungcsportal.com
Asia	gspn2.samsungcsportal.com
North & Latin America	gspn3.samsungcsportal.com
China	china.samsungportal.com

This Service Manual is a property of Samsung Electronics Co., Ltd.
Any unauthorized use of Manual can be punished under applicable
International and/or domestic law.

© Samsung Electronics Co., Ltd. Feb 2015.
Printed in Korea.
Code No. AC-00100E_1